

Quality
Punches
Pick-up Pilots
Pointed Punches
Guide Bushings

VERSATILE



Global leader in
providing fabrication
and stamping solutions

www.daytonprogress.com



PUNCHES AND PILOTS

• DJ_	Precision Ejector Punches	1.1
• DP_	Precision Non-ejector Punches	1.2
• DPT	Precision Pilots - Regular	1.3
• DPA	Precision Pilots - Positive Pick-Up	1.4
• DYX	Precision Straight Ejector Punches	1.5
• DUX	Precision Straight Regular Punches	1.6
• DJB	Headed Punch Blanks - Jektole®	1.7
• DPB	Headed Punch Blanks - Regular	1.8

CLOSE SPACE PUNCHES

• DCX	Precision Close Space Pointed Punches	2.1
• DVX	Precision Close Space 60° Pointed Punches	2.2
• DXX	Precision Close Space Straight Punches	2.3
• DWX	Precision Close Space 60° Straight Punches	2.4
• DCB	Precision Close Space Punch Blanks	2.5
• DVB	Precision Close Space Punch Blanks	2.6

GUIDE BUSHINGS

• DE_	Guide Bushings, head up	3.1
• DF_	Guide Bushings, head down	3.2
• DG_	Guide Bushings, headless	3.3
• DQX	Quill Bushings	3.4

MISCELLANEOUS

• Classified Shapes	4.1
• Locking Devices	4.2
• Jektole® Components	4.3

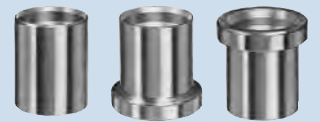

PRECISION HEADED PUNCHES TYPE DJ_ JEKTOLE®

Material	HRC
A2 (HWS)	60-63
M2 (M2)	60-63
PS (PS4)	63-65
Head	40-55

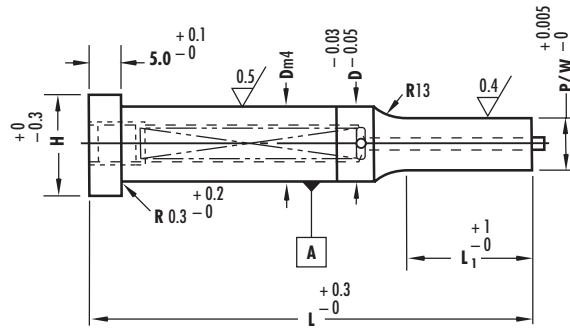
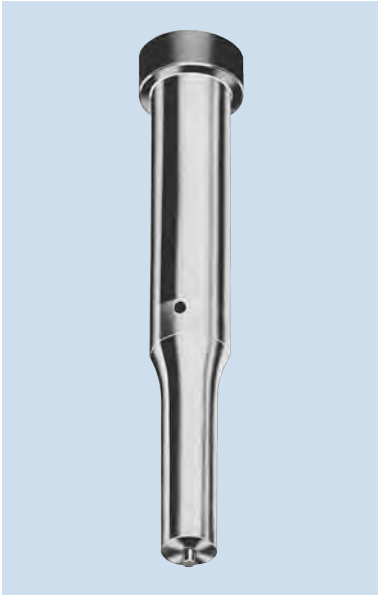

Precision Ejector Punches

Steel: A2, M2 and PS – please specify when ordering

DJX

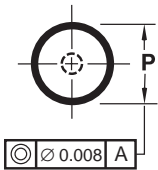

DJO

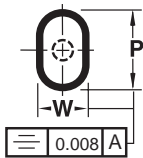

DJR

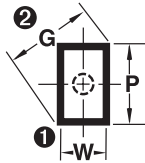

DJK

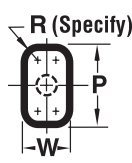

DJL

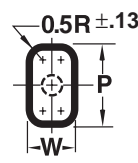

DJH

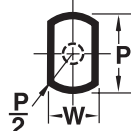

DJJ

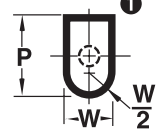

1 Sharp corners are typical. To assure proper clearance, Dayton will provide standard broken corners if matrix is ordered with punch to eliminate interference with matrix fillet when total clearance is 0.08 or less.

2 Check your P&W dimensions to be sure the diagonal G does not exceed the max. shown.

$$G = \sqrt{P^2 + W^2}$$

DJN



DJV

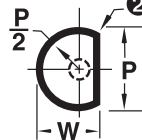

DJY

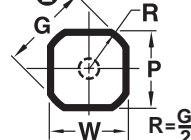

DJZ

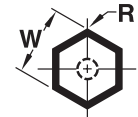

D	H	Point Length L ₁	Type & D DJX	Round Range P	Type & D DJ_	Shape		L													Jektole® Pin
						Min. W	Max. P/G	40.0	45.0	50.0	56.0	60.0	63.0	70.0	71.0	80.0	90.0	100.0			
05	08	8.0	DJX 05	1.60- 4.99	DJ_05	1.60- 5.00		0840	0845	0850	0856	0860	0863	0870	0871	0880				J2M	
06	09		DJX 06	2.40- 5.99	DJ_06	2.40- 6.00												0890	08100		J3M
05	08	13.0	DJX 05	1.60- 4.99	DJ_05	1.60- 5.00														J2M	
06	09		DJX 06	2.40- 5.99	DJ_06	2.40- 6.00															J3M
08	11		DJX 08	3.20- 7.99	DJ_08	3.20- 8.00															J4M
10	13		DJX 10	4.50- 9.99	DJ_10	4.50-10.00		1345													J6M
13	16		DJX 13	6.00-12.99	DJ_13	6.00-13.00			1350	1356	1360	1363	1370	1371	1380	1390	13100				J6M
16	19		DJX 16	8.00-15.99	DJ_16	7.20-16.00															J9M
20	23		DJX 20	9.50-19.99	DJ_20	8.00-20.00															J9M
25	28		DJX 25	12.00-24.99	DJ_25	9.00-25.00															J9M
32	35	DJX 32	16.00-31.99	DJ_32	10.00-32.00															J12M	

D	H	Point Length L ₁	Typ & D DJX	Round Range P	Typ & D DJ_	Shape		L										Jektole® Pin			
						Min. W	Max. P/G	40.0	45.0	50.0	56.0	60.0	63.0	70.0	71.0	80.0	90.0		100.0		
05	08	19.0	DJX 05	1.60- 4.99	DJ_05	1.60- 5.00														J2M	
06	09		DJX 06	2.40- 5.99	DJ_06	2.40- 6.00															J3M
08	11		DJX 08	3.20- 7.99	DJ_08	3.20- 8.00		1945													J4M
10	13		DJX 10	4.50- 9.99	DJ_10	4.50-10.00															J6M
13	16		DJX 13	6.00-12.99	DJ_13	6.00-13.00															J6M
16	19		DJX 16	8.00-15.99	DJ_16	7.20-16.00															J9M
20	23		DJX 20	9.50-19.99	DJ_20	8.00-20.00			1950	1956	1960	1963	1970	1971	1980	1990	19100				J9M
25	28		DJX 25	12.00-24.99	DJ_25	9.00-25.00															J9M
32	35		DJX 32	16.00-31.99	DJ_32	10.00-32.00															J12M
40	43		DJX 40	20.00-40.00	DJ_40	8.00-40.00															
45	48		DJX 45	25.00-45.00	DJ_45	9.00-45.00															
50	53		DJX 50	30.00-50.00	DJ_50	10.00-50.00															
56	59		DJX 56	35.00-56.00	DJ_56	11.00-56.00															
63	66	DJX 63	40.00-63.00	DJ_63	12.00-63.00																
06	09	25.0	DJX 06	2.40- 5.99	DJ_06	1.60- 5.00														J3M	
08	11		DJX 08	3.20- 7.99	DJ_08	2.40- 6.00															J4M
10	13		DJX 10	4.50- 9.99	DJ_10	4.50-10.00															J6M
13	16		DJX 13	6.00-12.99	DJ_13	6.00-13.00															J6M
16	19		DJX 16	8.00-15.99	DJ_16	7.20-16.00															J9M
20	23		DJX 20	9.50-19.99	DJ_20	8.00-20.00			2556	2560	2563	2570	2571	2580	2590	25100					J9M
25	28		DJX 25	12.00-24.99	DJ_25	9.00-25.00															J9M
32	35		DJX 32	16.00-31.99	DJ_32	10.00-32.00															J12M
40	43		DJX 40	20.00-40.00	DJ_40	8.00-40.00															
45	48		DJX 45	25.00-45.00	DJ_45	9.00-45.00															
50	53		DJX 50	30.00-50.00	DJ_50	10.00-50.00															
56	59		DJX 56	35.00-56.00	DJ_56	11.00-56.00															
63	66		DJX 63	40.00-63.00	DJ_63	12.00-63.00															
40	43.0	30.0	DJX 40	20.00-40.00	DJ_40	8.00-40.00															
45	48.0		DJX 45	25.00-45.00	DJ_45	9.00-45.00															
50	53.0		DJX 50	30.00-50.00	DJ_50	10.00-50.00							3070	3071	3080	3090	30100				
56	59.0		DJX 56	35.00-56.00	DJ_56	11.00-56.00															
63	66.0		DJX 63	40.00-63.00	DJ_63	12.00-63.00															

Standard Alterations for DJ Jektol[®] Punches

Standard alterations are the ranges beyond those sizes listed in the catalogue which can be manufactured for a slight additional charge.

L ₁ Max. ▶	Type	D	Minimum P (Rounds)						Minimum W (Shapes)						Jektol [®] Pin	
			8	13	19	25	30	35	40	8	13	19	25	30		35
DJ_ 05			1.3	1.3	1.3	1.9	2.5	–	–	1.3	1.6	1.6	2.4	3.0	-	J2M
DJ_ 06			2.0	2.0	1.6	2.0	2.5	–	–	1.3	1.6	1.6	2.4	3.0	-	J3M
DJ_ 08			3.0	3.0	1.6	2.4	2.5	3.2	–	1.6	2.4	2.4	2.4	3.2	4.0	J4M
DJ_ 10			4.0	4.0	1.6	2.5	3.2	3.2	6.0	2.0	2.4	2.8	3.2	3.2	4.0	J6M
DJ_ 13			–	4.0	3.2	3.2	3.2	4.0	6.0	–	3.2	3.2	3.2	3.6	4.5	J6M
DJ_ 16			–	6.0	6.0	6.0	6.0	6.0	6.0	–	6.0	6.0	6.0	6.0	6.0	J9M
DJ_ 20			–	6.0	6.0	6.0	7.6	7.6	7.6	–	6.0	6.0	6.0	6.0	6.0	J9M
DJ_ 25			–	8.0	8.0	8.0	10.0	10.0	10.0	–	6.0	6.0	6.0	6.0	6.0	J9M
DJ_ 32			–	10.0	10.0	10.0	10.0	10.0	10.0	–	6.0	6.0	6.0	6.0	6.0	J12M

XP, XW

P & W Dimensions
Smaller than standard

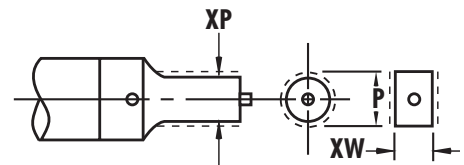

XBR

Point Length
Longer than standard

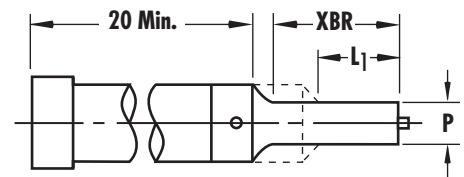

XD

Reduced Shank Diameter
Head Diameter does not change with body diameter.

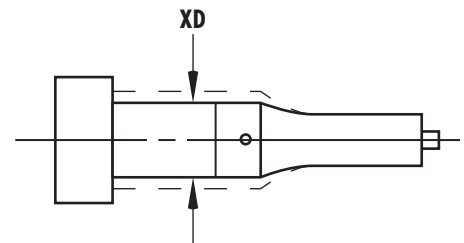

Shank Dia.	5.0	6.0	8.0	10.0	13.0	16.0	20.0	25.0	32.0
Min. XD	4.4	5.0	6.8	8.8	11.5	14.5	18.5	23.5	30.5

XL

Overall Length shortened (25 min.)
Stock removal from point end which shortens point length. To maintain point length specify „XBR“.

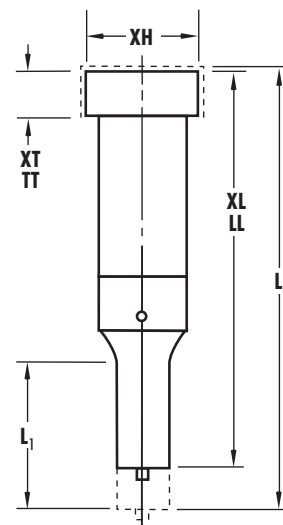

LL

Precision Overall Length
Same as XL except overall length is held to ± 0.02.

XT

Thinner Head than standard
Stock removal from head end which shortens overall length.

TT

Precision Head Thickness
Same as XT except head thickness tolerance is held to ± 0.01.

XH

Reduced Head Diameter
Minimum head diameter equals:
D + 0.00, – 0.03.

XLD

Alternate Lead Length

The XLD alteration fixes the punch shank length at 40 measured from the punch head. This eliminates pressing the entire shank through the holder.

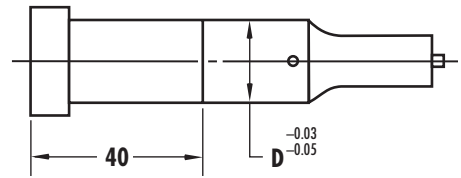

XN

DayTride® a unique wear resistant surface treatment for M2 and PS only.

XK

No Side Hole For air ejection. No cost.

XNT

DAYTiN® Titanium Nitride coating for extra wear. For M2 and PS only.

XJ

Smaller Jektole® Components
For additional information see page 4.3.1.

XNM

An exclusive PVD solidlubricant coating.

It provides a combination of lubricity and wear resistance not available from other PVD or CVD techniques. Produces a coefficient of friction lower than other coatings. Available on M2 and PS.

XCN

TiCN® PVD coating ultra hardness (harder than carbide) and superior abrasive wear resistance. For M2 and PS only.

KEY FLATS

The standard location for a key flat is Parallel to the P dimensions. For additional information see page 4.2.1.

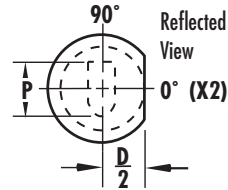

A DAYTON Difference JEKTOLE®

The "Triple Your Production" Punch
Retractable Slug Ejector.

Pat. No. 2.917.960 and 3.255.654

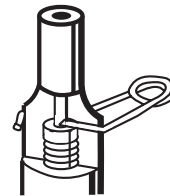

How to Order:

Specify: Quantity
Type
Shape & Length Codes
Steel
P or P&W Dimensions
Standard Alterations

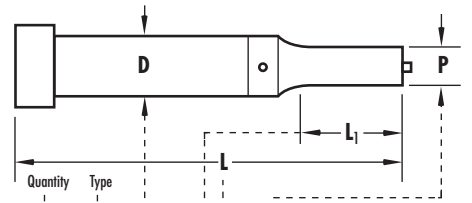

Quantity	Type			
2	DJX	08	1360	P7 25 A2
5	DJX	13	2580 M2	P11 52 XL 77.5
1	DJX	16	2571	P12.00 W8.00 PS X2
2	DJX	16	1990	P11.50 W10.50 R1.25 A2. X2

Standard Alterations for DP Regular Punches

Standard alterations are the ranges beyond those sizes listed in the catalogue which can be manufactured for a slight additional charge.

L ₁ Max. Type	D	8	13	19	25	30	35	40	8	13	19	25	30	35
		Minimum P (Rounds)							Minimum W (Shapes)					
DP_04	04	0.8	1.1	1.3	1.9	2.5	–	–	1.3	1.6	1.6	2.4	2.8	–
DP_05	05	1.0	1.3	1.3	1.9	2.5	–	–	1.3	1.6	1.6	2.4	3.0	–
DP_06	06	1.3	1.6	1.6	2.0	2.5	–	–	1.3	1.6	1.6	2.4	3.0	–
DP_08	08	1.6	1.6	1.6	2.4	2.5	3.2	–	1.6	2.4	2.4	2.4	3.2	4.0
DP_10	10	1.6	1.6	1.6	2.5	3.2	3.2	6.0	2.0	2.4	2.8	3.2	3.2	4.0
DP_13	13	–	3.2	3.2	3.2	3.2	4.0	6.0	–	3.2	3.2	3.2	3.6	4.5
DP_16	16	–	6.0	6.0	6.0	6.0	6.0	6.0	–	6.0	6.0	6.0	6.0	6.0
DP_20	20	–	6.0	6.0	6.0	7.6	7.6	7.6	–	6.0	6.0	6.0	6.0	6.0
DP_25	25	–	8.0	8.0	8.0	10.0	10.0	10.0	–	6.0	6.0	6.0	6.0	6.0
DP_32	32	–	10.0	10.0	10.0	10.0	10.0	10.0	–	6.0	6.0	6.0	6.0	6.0

XP, XW

P & W Dimensions
Smaller than standard

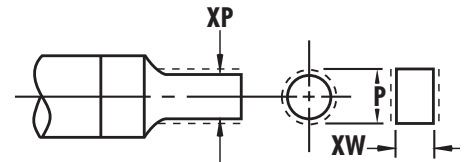

XBR

Point Length
Longer than standard

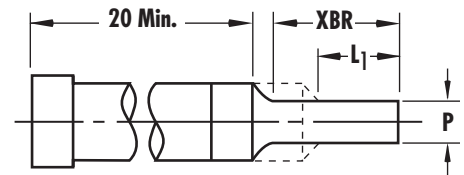

XD

Reduced Shank Diameter
Head Diameter does not change with body diameter.

Shank Dia.	4.0	5.0	6.0	8.0	10.0	13.0	16.0	20.0	25.0	32.0
Min. XD	2.5	3.5	4.5	6.5	8.5	11.5	14.5	18.5	23.5	30.5

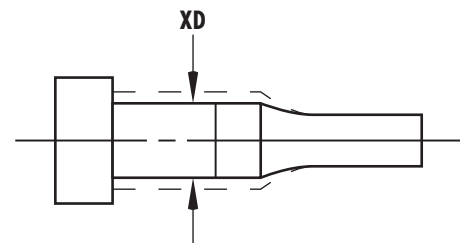

XL

Overall Length shortened (25 min.)
Stock removal from point end which shortens point length. To maintain point length specify „XBR“.

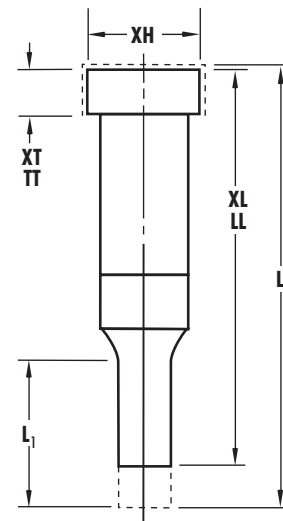

LL

Precision Overall Length
Same as XL except overall length is held to ± 0.02.

XT

Thinner Head than standard
Stock removal from head end which shortens overall length.

TT

Precision Head Thickness
Same as XT except head thickness tolerance is held to ± 0.01.

XH

Reduced Head Diameter
Minimum head diameter equals:
 $D + 0.00, - 0.03.$

XLD

Alternate Lead Length

The XLD alteration fixes the punch shank length at 40 measured from the punch head. This eliminates pressing the entire shank through the holder.

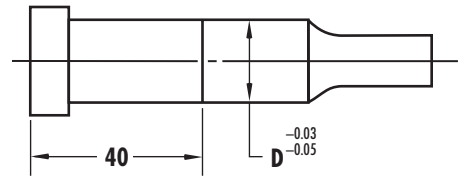

XN

DayTride® a unique wear resistant surface treatment for M2 and PS only.

XNT

DAYTiN® Titanium Nitride coating for extra wear. For M2 and PS only.

XNM

An exclusive PVD solidlubricant coating.

It provides a combination of lubricity and wear resistance not available from other PVD or CVD techniques. Produces a coefficient of friction lower than other coatings. Available on M2 and PS.

XCN

TiCN® PVD coating ultra hardness (harder than carbide) and superior abrasive wear resistance. For M2 and PS only.

KEY FLATS

The standard location for a key flat is Parallel to the P dimensions. For additional information see page 4.2.1.

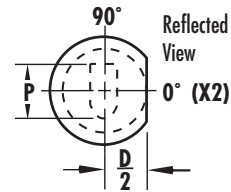

How to Order:

- Specify: Quantity
- Type
- Shape & Length Codes
- Steel
- P or P&W Dimensions
- Standard Alterations

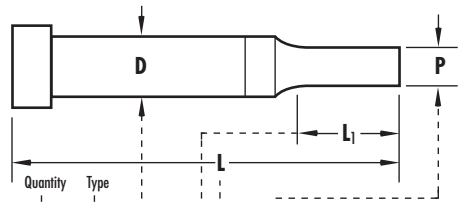

Quantity	Type			
2	DPX	10	0863	P5.00 A2 TT 5.00
6	DPJ	16	1990 M2	P13.00 W7.00 XBR 21.0
1	DPO	32	25100	P30.00 W16.00 PS X3 90°
2	DPK	20	1956	P15.95 W11.95 R0.95 A2 X2

PRECISION HEADED PILOTS TYPE DPT

Material	HRC
A2 (HWS)	60-63
M2 (HSS)	60-63
PS (PS4)	63-65
Head	40-55

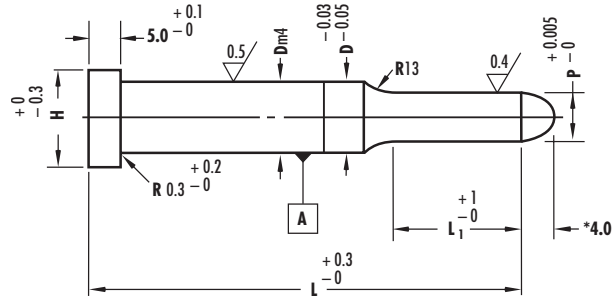
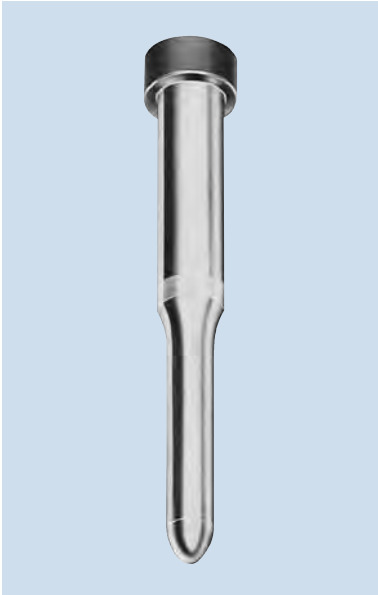

*Length slightly less for under 6.0 Ø.

Precision Pilots for Stock Control

Steel: A2, M2 and PS – please specify when ordering

DPT

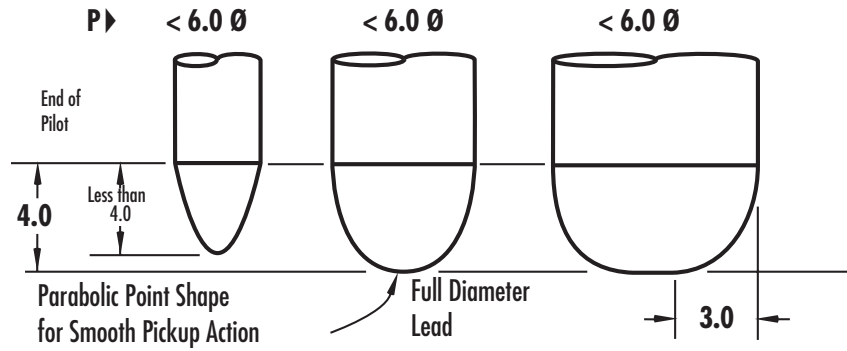
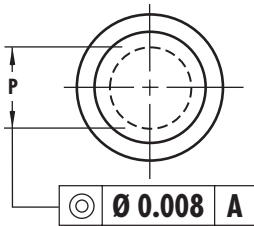

D	H	Point Length L	Type & D DPT	Round Range P	L											
					42.0	47.0	52.0	58.0	62.0	65.0	72.0	73.0	82.0	92.0	102.0	
04	07	10.0	DPT 04	1.55- 4.00												
05	08		DPT 05	1.55- 5.00												
06	09		DPT 06	1.55- 6.00	1042	1047	1052	1058	1062	1065	1072	1073	1082	1092	10102	
08	11		DPT 08	1.95- 8.00												
10	13		DPT 10	2.35-10.00												
04	07	15.0	DPT 04	1.55- 4.00												
05	08		DPT 05	1.55- 5.00												
06	09		DPT 06	1.55- 6.00												
08	11		DPT 08	2.35- 8.00												
10	13		DPT 10	3.15-10.00												
13	16		DPT 13	4.95-13.00		1547	1552	1558	1562	1565	1572	1573	1582	1592	15102	
16	19		DPT 16	7.95-16.00												
20	23		DPT 20	9.95-20.00												
25	28		DPT 25	11.95-25.00												
32	35		DPT 32	15.95-32.00												

D	H	Point Length L ₁	Type & D DPT	Round Range P	L											
					42.0	47.0	52.0	58.0	62.0	65.0	72.0	73.0	82.0	92.0	102.0	
04	07	21.0	DPT 04	1.55- 4.00												
05	08		DPT 05	1.55- 5.00												
06	09		DPT 06	1.55- 6.00												
08	11		DPT 08	2.35- 8.00												
10	13		DPT 10	3.15-10.00		2147	2152	2158	2162	2165	2172	2173	2182	2192	21102	
13	16		DPT 13	4.95-13.00												
16	19		DPT 16	7.95-16.00												
20	23		DPT 20	9.95-20.00												
25	28		DPT 25	11.95-25.00												
32	35		DPT 32	15.95-32.00												
04	07	27.0	DPT 04	1.55- 4.00												
05	08		DPT 05	1.55- 5.00												
06	09		DPT 06	1.55- 6.00												
08	11		DPT 08	2.35- 8.00												
10	13		DPT 10	3.15-10.00				2758	2762	2765	2772	2773	2782	2792	27102	
13	16		DPT 13	4.95-13.00												
16	19		DPT 16	7.95-16.00												
20	23		DPT 20	9.95-20.00												
25	28		DPT 25	11.95-25.00												
32	35		DPT 32	15.95-32.00												

Standard Alterations for DPT Pilots

Standard alterations are the ranges beyond those sizes listed in the catalogue which can be manufactured for a slight additional charge.

L ₁	Max. 	Minimum P (Rounds)						
		10	15	21	27	32	37	42
DPT	04	1.55	1.55	1.55	1.85	2.45	-	-
DPT	05	1.55	1.55	1.55	1.85	2.45	-	-
DPT	06	1.55	1.55	1.55	1.95	2.45	-	-
DPT	08	1.55	1.55	1.55	2.35	2.45	3.15	
DPT	10	1.55	1.55	1.55	2.45	3.15	3.15	5.95
DPT	13	-	3.15	3.15	3.15	3.15	3.95	5.95
DPT	16	-	5.95	5.95	5.95	5.95	5.95	5.95
DPT	20	-	5.95	5.95	5.95	7.55	7.55	7.55
DPT	25	-	7.95	7.95	7.95	9.95	9.95	9.95
DPT	32	-	9.95	9.95	9.95	9.95	9.95	9.95

XP

P Dimension
Smaller than standard

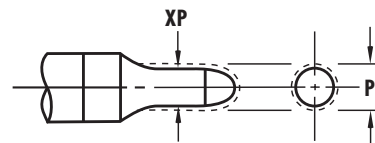

XBR Point Length
Longer than standard

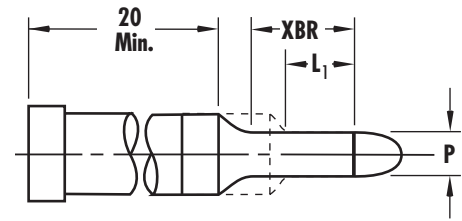

XD Reduced Shank Diameter
Head Diameter does not change with body diameter.

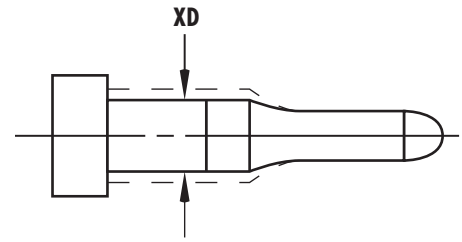

Shank Dia.	4.0	5.0	6.0	8.0	10.0	13.0	16.0	20.0	25.0	32.0
Min. XD	2.5	3.5	4.5	6.5	8.5	11.5	14.5	18.5	23.5	30.5

XL Overall Length shortened (25 min.)
Stock removal from point end which shortens point length. To maintain point length specify „XBR“.

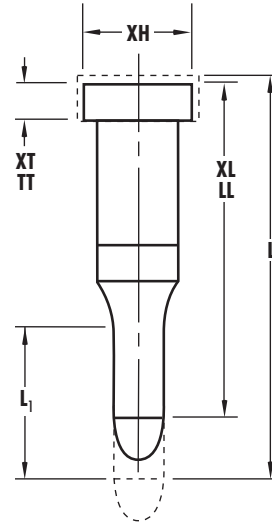

XT Thinner Head than standard
Stock removal from head end which shortens overall length.

TT Precision Head Thickness
Same as XT except head thickness tolerance is held to ± 0.01 .

XH Reduced Head Diameter
Minimum head diameter equals: $D + 0.00, - 0.03$.

XLD Alternate Lead Length
The XLD alteration fixes the punch shank length at 40 measured from the punch head. This eliminates pressing the entire shank through the holder.

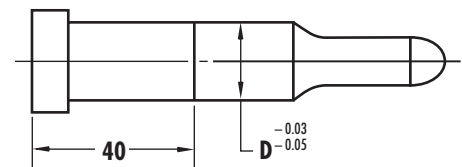

XN DayTride® a unique wear resistant surface treatment for M2 and PS only.

XNT DAYTiN® Titanium Nitride coating for extra wear. For M2 and PS only.

XNM An exclusive PVD solidlubricant coating. It provides a combination of lubricity and wear resistance not available from other PVD or CVD techniques. Produces a coefficient of friction lower than other coatings. Available on M2 and PS.

XCN TiCN® PVD coating ultra hardness (harder than carbide) and superior abrasive wear resistance. For M2 and PS only.

How to Order:

Specify: Quantity
Type
Shape & Length Codes
Steel
P Dimension
Standard Alterations

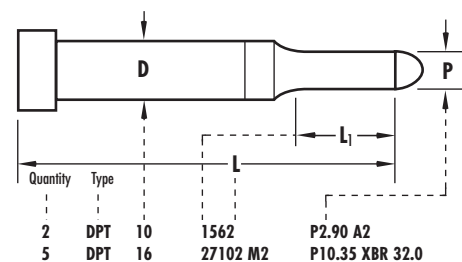

PRECISION POSITIVE PICK-UP HEADED PILOTS TYPE DPA

Material	HRC
M2 (HSS)	60-63
Head	40-55

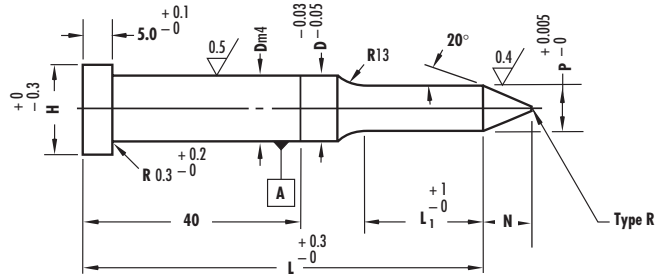
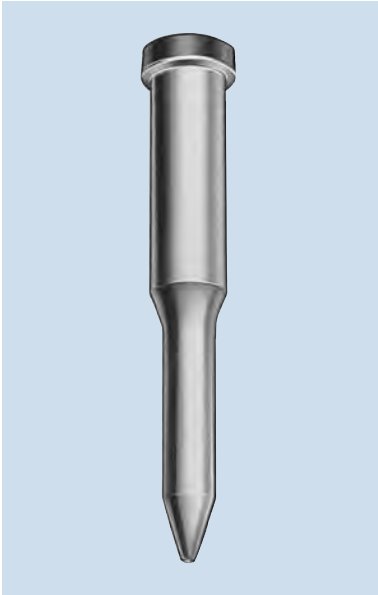

Precision Pilots for Greater Stock Movement
Available in lengths between 62 and 142 mm

Steel: M2 – please specify when ordering

DPA

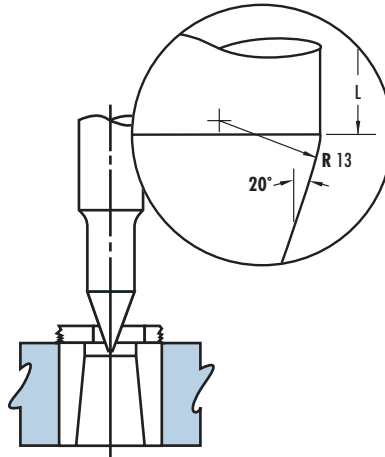
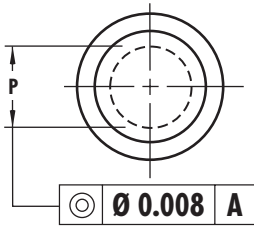

Geometry provides smoother pick up without risk of distortion of hole.

Greater Positioning – moves stock further than conventional pilots.

D	H	Point Length L ₁	Type & D DPA	Round Range P	Nose Length N	L									
						62.0	65.0	72.0	73.0	82.0	92.0	102.0	112.0	127.0	142.0
10	13	21.0	DPA 10	4.85-10.00	8.0	2162	2165	2172	2173	2182	2192	21102	21112	21127	21142
13	16		DPA 13	6.30-13.00	10.0										
16	19		DPA 16	9.95-16.00	15.0										
20	23		DPA 20	13.60-20.00	20.0										
25	28		DPA 25	17.25-25.00	25.0										
32	35		DPA 32	20.85-32.00	30.0										
10	13	27.0	DPA 10	4.85-10.00	8.0	2762	2765	2772	2773	2782	2792	27102	27112	27127	27142
13	16		DPA 13	6.30-13.00	10.0										
16	19		DPA 16	9.95-16.00	15.0										
20	23		DPA 20	13.60-20.00	20.0										
25	28		DPA 25	17.25-25.00	25.0										
32	35		DPA 32	20.85-32.00	30.0										
32	35	32.0	DPA 32	20.85-32.00	30.0			3272	3273	3282	3292	32102	32112	32127	32142

When P = D Shank tolerance applies to full length

Standard Alterations for DPA Positive Pick-Up Pilots

Standard alterations are the ranges beyond those sizes listed in the catalogue which can be manufactured for a slight additional charge.

Type	Code	Minimum P (Rounds)						
		10	15	21	27	32	37	42
DPA	10	2.10	2.10	2.10	2.10	3.15	3.15	5.95
DPA	13	—	3.15	3.15	3.15	3.15	3.95	5.95
DPA	16	—	5.95	5.95	5.95	5.95	5.95	5.95
DPA	20	—	5.95	5.95	5.95	7.55	7.55	7.55
DPA	25	—	7.95	7.95	7.95	9.95	9.95	9.95
DPA	32	—	9.95	9.95	9.95	9.95	9.95	9.95

All diameters of XP reduce point length „N“.

XP

P Dimension
Smaller than standard

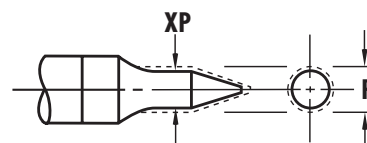

XBR

Point Length
Longer than standard

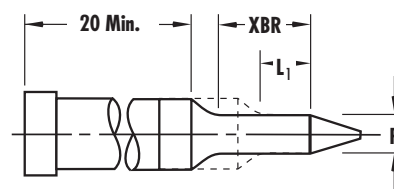

XD

Reduced Shank Diameter
Head Diameter does not change with body diameter.

Shank Dia.	10.0	13.0	16.0	20.0	25.0	32.0
Min. XD	8.5	11.5	14.5	18.5	23.5	30.5

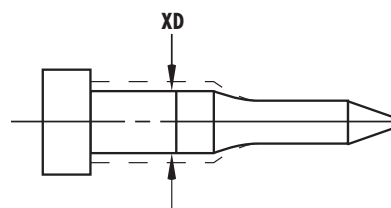

XL

Overall Length shortened (25 min.)
Stock removal from point end which shortens point length. To maintain point length specify „XBR“.

XT

Thinner Head than standard
Stock removal from head end which shortens overall length.

TT

Precision Head Thickness
Same as XT except head thickness tolerance is held to ± 0.01 .

XH

Reduced Head Diameter
Minimum head diameter equals:
 $D + 0.00, - 0.03$.

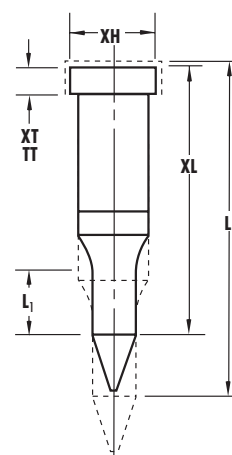

XN

DayTride® a unique wear resistant surface treatment for M2 only.

XNT

DAYTiN® Titanium Nitride coating for extra wear. For M2 only.

How to Order:

Specify: Quantity
Type
Shape & Length Codes
Steel
P Dimension
Standard Alterations

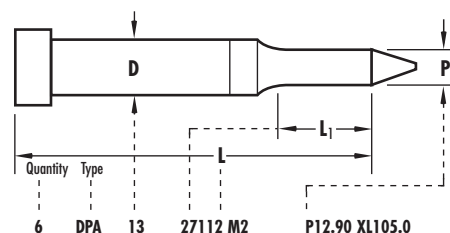

PRECISION STRAIGHT HEADED PUNCHES TYPE DYX JEKTOLE®

Material	HRC
A2 (HWS)	60-63
M2 (HSS)	60-63
Head	40-55

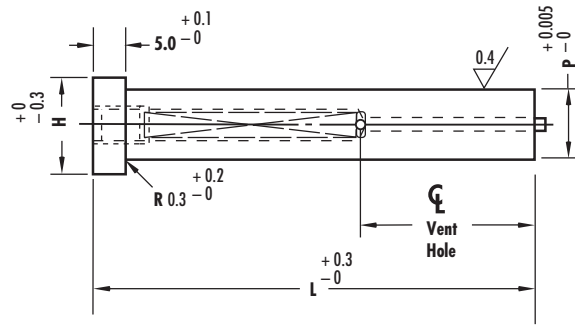
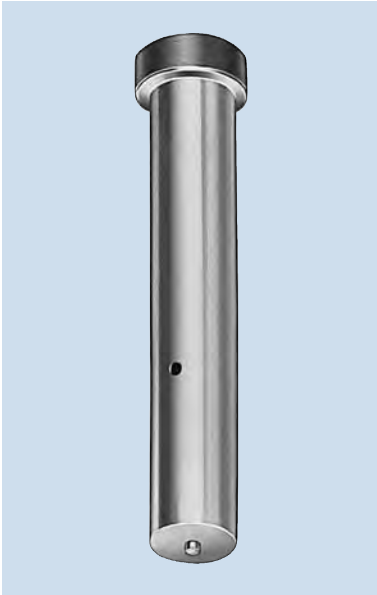

Jektole®

Steel: A2 and M2 – please specify when ordering

DYX

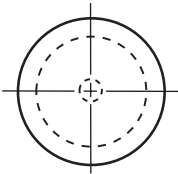

P	Range H	φ Vent Hole	L											Jektole® Pin	
			32.0	40.0	45.0	50.0	56.0	60.0	63.0	70.0	71.0	80.0	90.0		
5.000- 6.000	9.0	14.0	32	40	45	50	56								J2M
6.001- 8.000	11.0	14.0	32	40	45										J3M
		21.3				50	56	60	63	70	71	80		J3M	
8.000-10.000	13.0	15.2	32	40	45										J4M
		22.5				50	56	60	63	70	71	80	90	J4M	
10.001-13.000	16.0	22.5		40	45	50	56								J6M
		27.9						60	63	70	71	80	90	J6M	
13.000-16.000	19.0	22.5		40	45	50	56								J9M
		27.9						60	63	70	71	80	90	J9M	

Standard Alterations for **DYX** Straight Punches

Standard alterations are the ranges beyond those sizes listed in the catalogue which can be manufactured for a slight additional charge.

XL **Overall Length shortened (25 min.)**
Stock removal from point end which shortens point length.

LL **Precision Overall Length**
Same as XL except overall length is held to ± 0.02 .

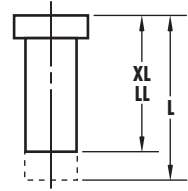

XT **Thinner Head than standard**
Stock removal from head end which shortens overall length.

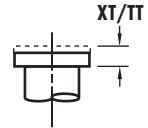

TT **Precision Head Thickness**
Same as XT except head thickness tolerance is held to ± 0.01 .

XH **Reduced Head Diameter**
Minimum head diameter equals $D + 0.00, - 0.03$.

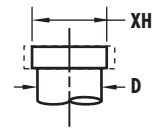

XN **DayTride®** a unique wear resistant surface treatment for M2 only.

XNT **DAYTiN®** Titanium Nitride coating for extra wear. For M2 only.

XNM **An exclusive PVD solidlubricant coating.**
It provides a combination of lubricity and wear resistance not available from other PVD or CVD techniques. Produces a coefficient of friction lower than other coatings. Available on M2.

XCN **TiCN®** PVD coating ultra hardness (harder than carbide) and superior abrasive wear resistance. For M2 only.

How to Order:

Specify: Quantity	2
Type	DYX
Length Code	56
P or P&W Dimensions	P6.005
Steel	A2
Standard Alterations	XL

PRECISION STRAIGHT HEADED PUNCHES TYPE DUX REGULAR

Material	HRC
A2 (HWS)	60-63
M2 (HSS)	60-63
Head	40-55

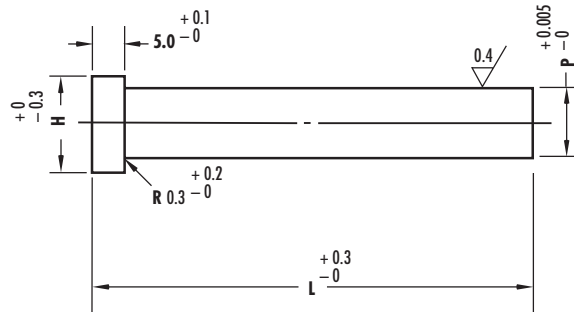
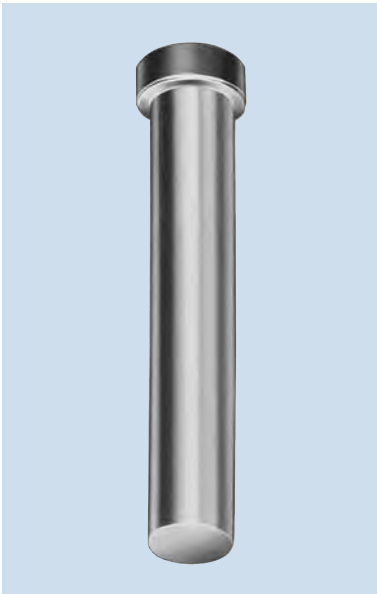

Standard

Steel: A2 and M2 – please specify when ordering

DUX

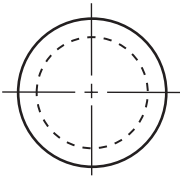

Range P	H	L												
		32.0	40.0	45.0	50.0	56.0	60.0	63.0	70.0	71.0	80.0	90.0	100.0	
3.000- 4.000	7.0													
4.001- 5.000	8.0													
5.001- 6.000	9.0													
6.001- 8.000	11.0	32	40	45	50	56	60	63	70	71	80	90	100	
8.001-10.000	13.0													
10.001-13.000	16.0													
13.001-16.000	19.0													

Standard Alterations for DUX Straight Punches

Standard alterations are the ranges beyond those sizes listed in the catalogue which can be manufactured for a slight additional charge.

XL Overall Length shortened (25 min.)
Stock removal from point end which shortens point length.

LL Precision Overall Length
Same as XL except overall length is held to ± 0.02 .

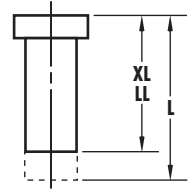

XT Thinner Head than standard
Stock removal from head end which shortens overall length.

TT Precision Head Thickness
Same as XT except head thickness tolerance is held to ± 0.01 .

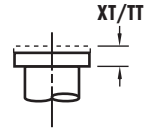

XH Reduced Head Diameter
Minimum head diameter equals $D + 0.00, - 0.03$.

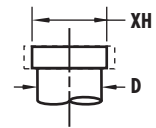

XN DayTride® a unique wear resistant surface treatment for M2 only.

XNT DAYTiN® Titanium Nitride coating for extra wear. For M2 only.

XNM An exclusive PVD solidlubricant coating. It provides a combination of lubricity and wear resistance not available from other PVD or CVD techniques. Produces a coefficient of friction lower than other coatings. Available on M2.

XCN TiCN® PVD coating ultra hardness (harder than carbide) and superior abrasive wear resistance. For M2 only.

How to Order:

Specify: Quantity	5
Type	DUX
Length Code	70
P or P&W Dimensions	P9.50
Steel	M2
Standard Alterations	XL

HEADED PUNCH BLANKS TYPE DJB JEKTOLE®

Material	HRC
A2 (HWS)	60-63
M2 (HSS)	60-63
PS (PS4)	63-65
Head	40-55

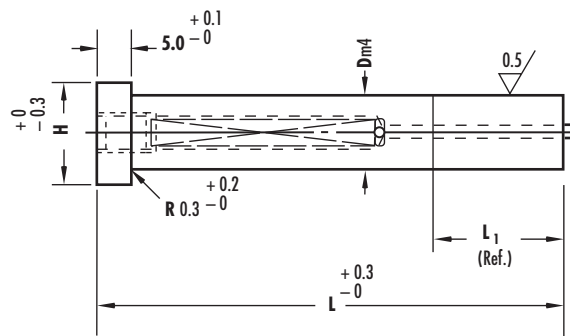
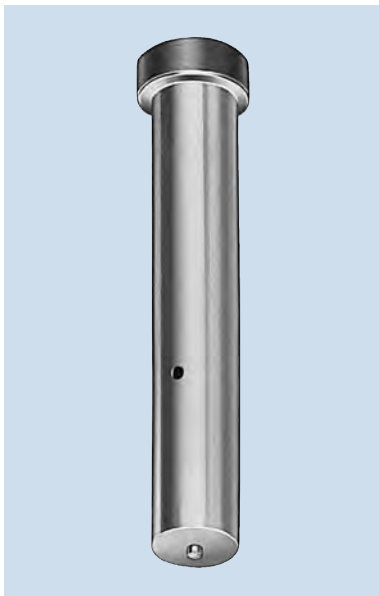

Jektole®

Steel: A2, M2 and PS – please specify when ordering

DJB

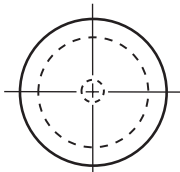

D	H	Point Length L ₁ (Ref.)	Type & D	L													Jektole® Pin	
				32.0	40.0	45.0	50.0	56.0	60.0	63.0	70.0	71.0	80.0	90.0	100.0			
05	8.0	13.0	DJB 05		0840*													J2M
06	9.0		DJB 06															J3M
08	11.0		DJB 08															J4M
10	13.0		DJB 10															J6M
13	16.0		DJB 13			1345	1350	1356	1360	1363	1370	1371	1380	1390	13100			J6M
16	19.0		DJB 16															J9M
20	23.0		DJB 20															J9M
25	28.0		DJB 25															J9M
32	35.0		DJB 32															J12M
05	8.0	25.0	DJB 05					1956*	1960*	1963*	1970*	1971*	1980*					J2M
06	9.0		DJB 06															J3M
08	11.0		DJB 08															J4M
10	13.0		DJB 10			1945*	1950*	2556	2560	2563	2570	2571	2580	2590	25100			J6M
13	16.0		DJB 13															J6M
16	19.0		DJB 16															J9M
20	23.0		DJB 20															J9M
25	28.0		DJB 25															J9M
32	35.0		DJB 32						1960*									J12M

*Max SBR 8 and 19

Standard Alterations for DJB Punch Blanks

Standard alterations are the ranges beyond those sizes listed in the catalogue which can be manufactured for a slight additional charge.

XL **Overall Length shortened (25 min.)**
Stock removal from point end which shortens point length.

LL **Precision Overall Length**
Same as XL except overall length is held to ± 0.02 .

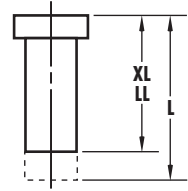

XT **Thinner Head than standard**
Stock removal from head end which shortens overall length.

TT **Precision Head Thickness**
Same as XT except head thickness tolerance is held to ± 0.01 .

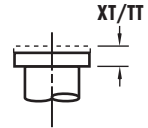

XH **Reduced Head Diameter**
Minimum head diameter equals $D + 0.00, - 0.03$.

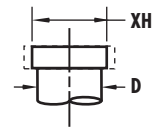

XN **DayTride®** a unique wear resistant surface treatment for M2 and PS only.

XNT **DAYTiN®** Titanium Nitride coating for extra wear. For M2 and PS only.

XNM **An exclusive PVD solidlubricant coating.**
It provides a combination of lubricity and wear resistance not available from other PVD or CVD techniques. Produces a coefficient of friction lower than other coatings. Available on M2 and PS.

XCN **TiCN®** PVD coating ultra hardness (harder than carbide) and superior abrasive wear resistance. For M2 and PS only.

How to Order:

Specify: Quantity	4
Type	DJB
Length Code	71
Steel	M2

HEADED PUNCH BLANKS TYPE DPB REGULAR

Material	HRC
A2 (HWS)	60-63
M2 (HSS)	60-63
PS (PS4)	63-65
Head	40-55

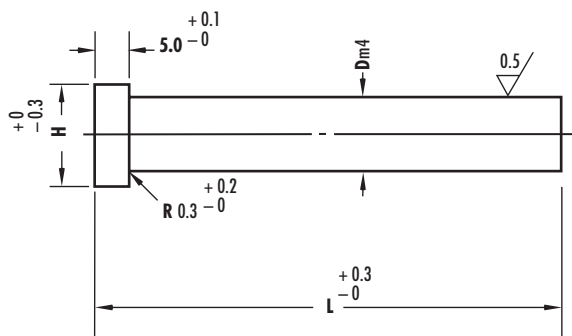
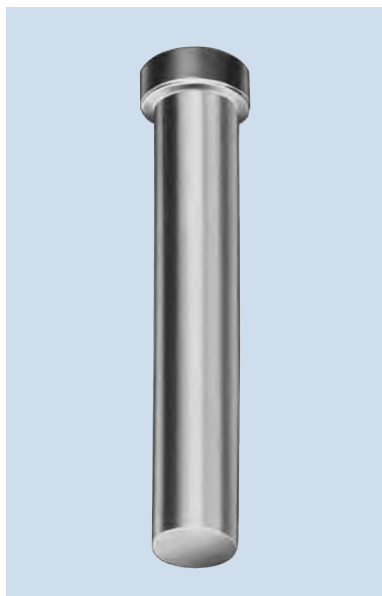

Standard

Steel: A2, M2 and PS – please specify when ordering

DPB

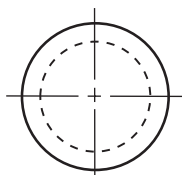

D	H	Point Length L ₁ (Ref.)	Type & D D_B	L												
				32.0	40.0	45.0	50.0	56.0	60.0	63.0	70.0	71.0	80.0	90.0	100.0	
04	7.0	As Req'd	DPB 04													
05	8.0		DPB 05													
06	9.0		DPB 06													
08	11.0		DPB 08													
10	13.0		DPB 10													
13	16.0		DPB 13		32	40	45	50	56	60	63	70	71	80	90	100
16	19.0		DPB 16													
20	23.0		DPB 20													
25	28.0		DPB 25													
32	35.0		DPB 32													

Standard Alterations for DPB Punch Blanks

Standard alterations are the ranges beyond those sizes listed in the catalogue which can be manufactured for a slight additional charge.

XL **Overall Length shortened (25 min.)**
Stock removal from point end which shortens point length. To maintain point length specify „XBR“.

LL **Precision Overall Length**
Same as XL except overall length is held to ± 0.02 .

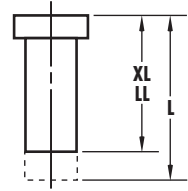

XT **Thinner Head than standard**
Stock removal from head end which shortens overall length.

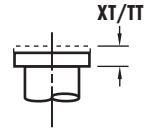

TT **Precision Head Thickness**
Same as XT except head thickness tolerance is held to ± 0.01 .

XH **Reduced Head Diameter**
Minimum head diameter equals $D + 0.00, - 0.03$.

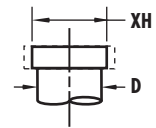

XN **DayTride®** a unique wear resistant surface treatment for M2 and PS only.

XNT **DAYTiN®** Titanium Nitride coating for extra wear. For M2 and PS only.

XNM **An exclusive PVD solidlubricant coating.**
It provides a combination of lubricity and wear resistance not available from other PVD or CVD techniques. Produces a coefficient of friction lower than other coatings. Available on M2 and PS.

XCN **TiCN®** PVD coating ultra hardness (harder than carbide) and superior abrasive wear resistance. For M2 and PS only.

How to Order:

Specify: Quantity	3
Type	DPB
Shank & Length Codes	63
Steel	PS

CLOSE SPACE HEADED PUNCHES TYPE DCX

Material	HRC
A2 (HWS)	60-63
M2 (HSS)	60-63
Head	40-55

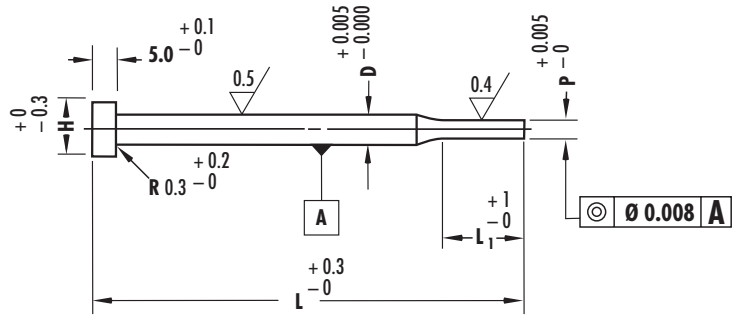

**Pointed Punches
For Precision Close Space Holes**

Steel: A2 and M2 – please specify when ordering

Body D	Head Dia. H	Point Length L ₁	Range P	L										
				40.0	45.0	50.0	56.0	60.0	63.0	70.0	71.0	80.0		
2.0	4.0	5.0	0.81-1.60											
3.0	5.0	7.0	2.01-3.00											
4.0	6.0	8.0	3.01-4.00	40	45	50	56	60	63	70	71	80		
5.0	7.0	8.0	4.01-5.00											
6.0	8.0	8.0	5.01-6.00											
7.0	9.0	8.0	6.01-7.00											

Standard Alterations for DCX CloSPACE Punches

Standard alterations are the ranges beyond those sizes listed in the catalogue which can be manufactured for a slight additional charge.

XP P Dimension
Smaller than standard

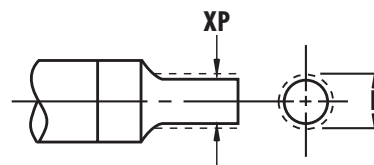

XBR Point Length
Longer than standard

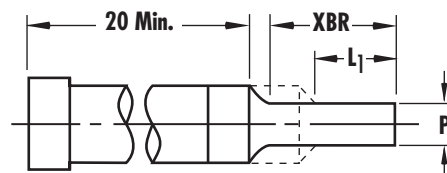

XD Reduced Shank Diameter
Head Diameter does not change with body diameter.

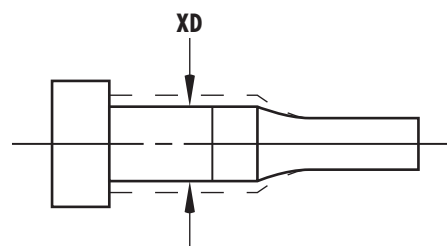

Shank Dia.	4.0	5.0	6.0	8.0	10.0	13.0	16.0	20.0	25.0	32.0
Min. XD	2.5	3.5	4.5	6.5	8.5	11.5	14.5	18.5	23.5	30.5

XL Overall Length shortened (25 min.)
Stock removal from point end which shortens point length. To maintain point length specify „XBR“.

LL Precision Overall Length
Same as XL except overall length is held to ± 0.02 .

XT Thinner Head than standard
Stock removal from head end which shortens overall length.

TT Precision Head Thickness
Same as XT except head thickness tolerance is held to ± 0.01 .

XH Reduced Head Diameter
Minimum head diameter equals:
 $D + 0.00, - 0.03$.

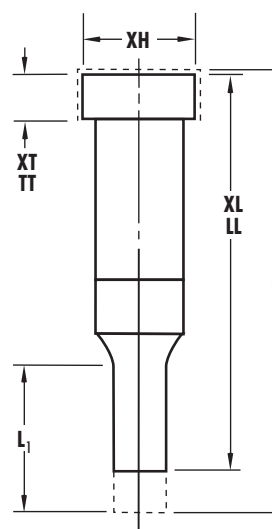

XN DayTride® a unique wear resistant surface treatment for M2 only.

XNT DAYTiN® Titanium Nitride coating for extra wear. For M2 only.

XNM An exclusive PVD solidlubricant coating. It provides a combination of lubricity and wear resistance not available from other PVD or CVD techniques. Produces a coefficient of friction lower than other coatings. Available on M2.

XCN TiCN® PVD coating ultra hardness (harder than carbide) and superior abrasive wear resistance. For M2 only.

How to Order:

Specify: Quantity
Type
Shank & Length Codes
Steel
P Dimension
Standard Alterations

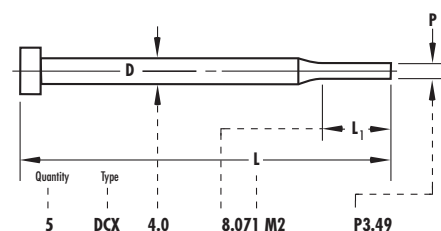

CLOSE SPACE PUNCHES TYPE DVX

Material	HRC
M2 (HSS)	60-63
Head	40-55

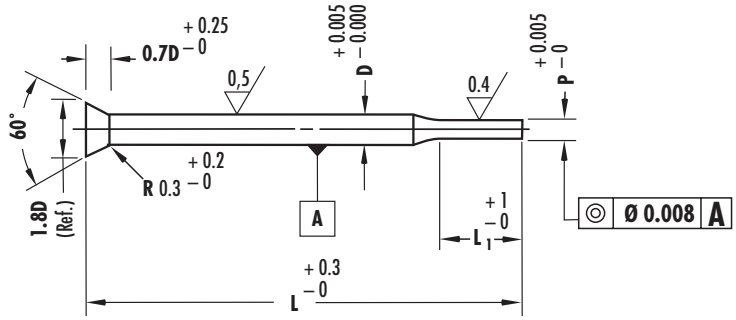
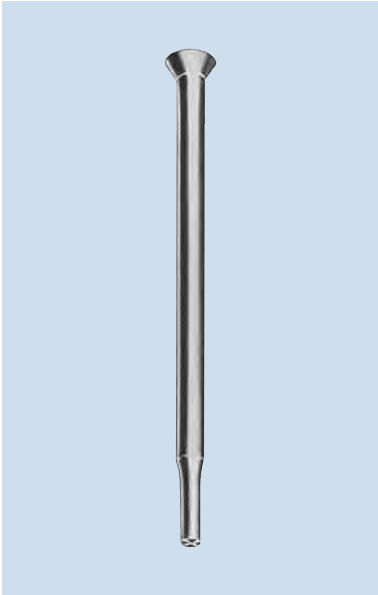

For Precision Close Space Holes

Steel: M2 – please specify when ordering

Body D	Head Dia. H	Point Length L ₁	Range P	L										
				40.0	45.0	50.0	56.0	60.0	63.0	70.0	71.0	80.0		
2.0	4.0	5.0	0.81-1.60											
3.0	5.0	7.0	2.01-3.00											
4.0	6.0	8.0	3.01-4.00	40	45	50	56	60	63	70	71	80		
5.0	7.0	8.0	4.01-5.00											
6.0	8.0	8.0	5.01-6.00											
7.0	9.0	8.0	6.01-7.00											

Standard Alterations for DVX CloSPACE Punches

Standard alterations are the ranges beyond those sizes listed in the catalogue which can be manufactured for a slight additional charge.

XP P Dimension
Smaller than standard

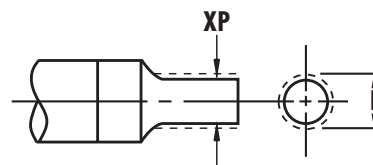

XBR Point Length
Longer than standard

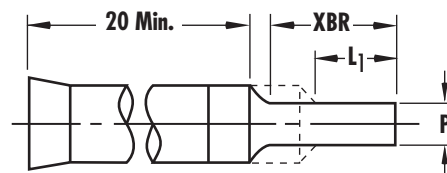

XL Overall Length shortened (25 min.)
Stock removal from point end which shortens point length. To maintain point length specify „XBR“.

LL Precision Overall Length
Same as XL except overall length is held to ± 0.02 .

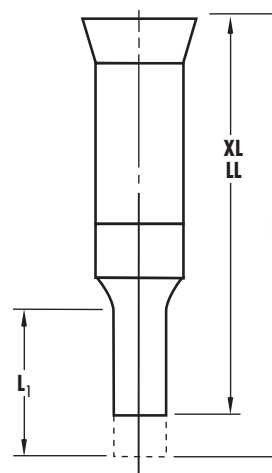

XN DayTride® a unique wear resistant surface treatment for M2 only.

XNT DAYTiN® Titanium Nitride coating for extra wear. For M2 only.

XNM An exclusive PVD solidlubricant coating. It provides a combination of lubricity and wear resistance not available from other PVD or CVD techniques. Produces a coefficient of friction lower than other coatings. Available on M2.

XCN TiCN® PVD coating ultra hardness (harder than carbide) and superior abrasive wear resistance. For M2 only.

How to Order:

Specify: Quantity
Type
Shank & Length Codes
Steel
P Dimension
Standard Alterations

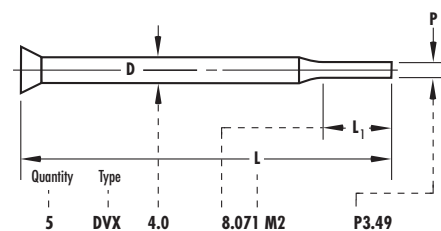

CLOSE SPACE STRAIGHT HEADED PUNCHES TYPE DXX

Material	HRC
A2 (HWS)	60-63
M2 (HSS)	60-63
Head	40-55

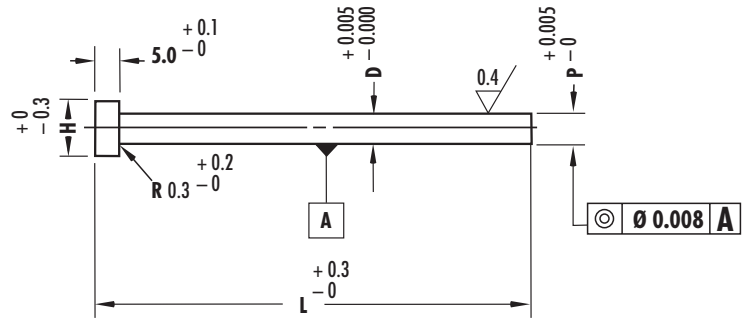

**Straight Punch
For Precision Close Space Holes**

Steel: A2 and M2 – please specify when ordering

Head Dia. H	Range P	L								
		40.0	45.0	50.0	56.0	60.0	63.0	70.0	71.0	80.0
3.0	0.81-1.60									
4.0	1.61-2.00									
5.0	2.01-3.00									
6.0	3.01-4.00	40	45	50	56	60	63	70	71	80
7.0	4.01-5.00									
8.0	5.01-6.00									
9.0	6.01-7.00									

Standard Alterations for DXX Closspace Punches

Standard alterations are the ranges beyond those sizes listed in the catalogue which can be manufactured for a slight additional charge.

XL Overall Length shortened
Stock removal from point end.

LL Precision Overall Length
Same as XL except overall length is held to ± 0.02 .

XT Thinner Head than standard
Stock removal from head end which shortens overall length.

TT Precision Head Thickness
Same as XT except head thickness tolerance is held to ± 0.01 .

XH Reduced Head Diameter
Minimum head diameter equals:
 $D + 0.00, - 0.03$.

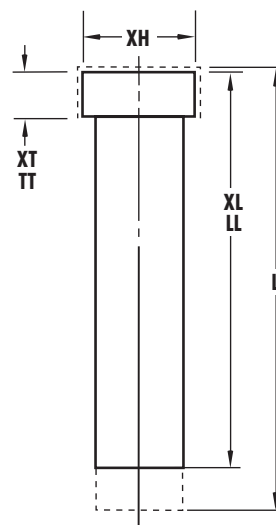

XN DayTride® a unique wear resistant surface treatment for M2 only.

XNT DAYTiN® Titanium Nitride coating for extra wear. For M2 only.

XNM An exclusive PVD solidlubricant coating. It provides a combination of lubricity and wear resistance not available from other PVD or CVD techniques. Produces a coefficient of friction lower than other coatings. Available on M2.

XCN TiCN® PVD coating ultra hardness (harder than carbide) and superior abrasive wear resistance. For M2 only.

How to Order:

Specify: Quantity
Type
Length Code
Steel
P Dimension
Standard Alterations

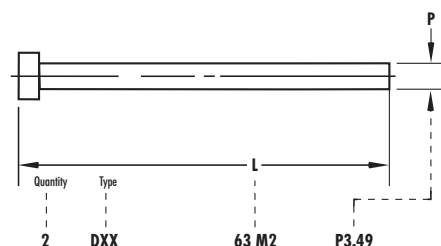

CLOSE SPACE PUNCHES TYPE DWX

Material	HRC
M2 (HSS)	60-63
Head	40-55

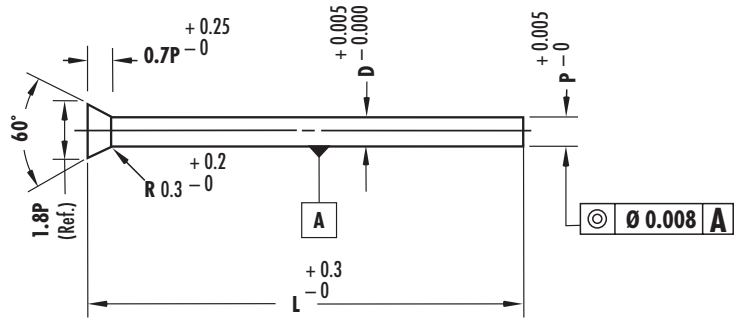
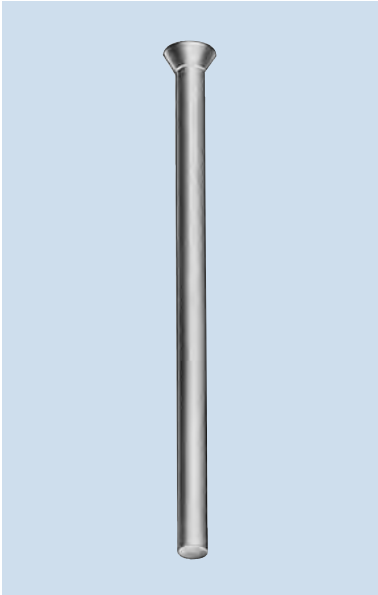

For Precision Close Space Holes

Steel: M2 – please specify when ordering

Head Dia. H	Range P	L								
		40.0	45.0	50.0	56.0	60.0	63.0	70.0	71.0	80.0
3.0	0.81-1.60									
4.0	1.61-2.00									
5.0	2.01-3.00									
6.0	3.01-4.00	40	45	50	56	60	63	70	71	80
7.0	4.01-5.00									
8.0	5.01-6.00									
9.0	6.01-7.00									

Standard Alterations for DWX CloSPACE Punches

Standard alterations are the ranges beyond those sizes listed in the catalogue which can be manufactured for a slight additional charge.

XL Overall Length shortened
Stock removal from point end.

LL Precision Overall Length
Same as XL except overall length is held to ± 0.02 .

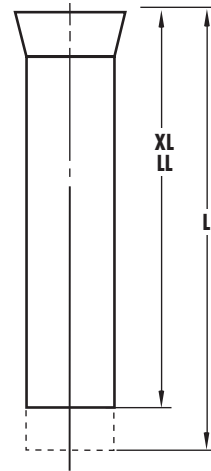

XN DayTride® a unique wear resistant surface treatment.

XNT DAYTiN® Titanium Nitride coating for extra wear.

XNM An exclusive PVD solidlubricant coating. It provides a combination of lubricity and wear resistance not available from other PVD or CVD techniques. Produces a coefficient of friction lower than other coatings.

XCN TiCN® PVD coating ultra hardness (harder than carbide) and superior abrasive wear resistance.

How to Order:

Specify: Quantity
Type
Length Code
Steel
P Dimension
Standard Alterations

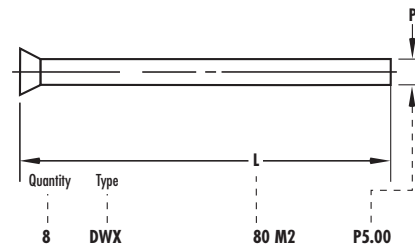

CLOSE SPACE HEADED PUNCHES TYPE DCB

Material	HRC
A2 (HWS)	60-63
M2 (HSS)	60-63
Head	40-55

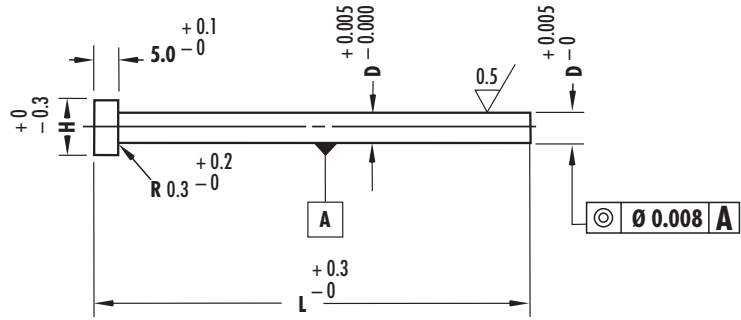
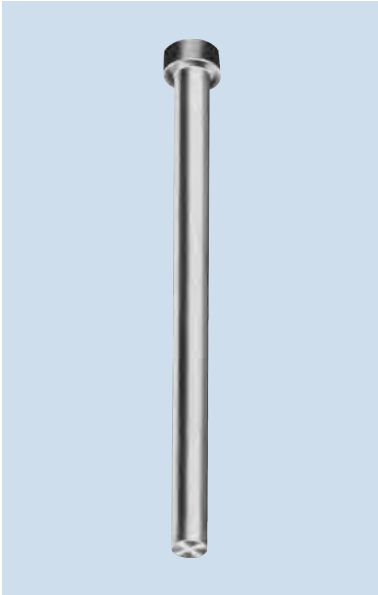

**Punch Blanks
For Precision Close Space Holes**

Steel: A2 and M2 – please specify when ordering

Body D	Head Dia. H	L								
		40.0	45.0	50.0	56.0	60.0	63.0	70.0	71.0	80.0
2.0	4.0									
3.0	5.0									
4.0	6.0									
5.0	7.0	40	45	50	56	60	63	70	71	80
6.0	8.0									
7.0	9.0									

Standard Alterations for DCB Cloospace Punches

Standard alterations are the ranges beyond those sizes listed in the catalogue which can be manufactured for a slight additional charge.

XL Overall Length shortened
Stock removal from point end.

LL Precision Overall Length
Same as XL except overall length is held to ± 0.02 .

XT Thinner Head than standard
Stock removal from head end which shortens overall length.

TT Precision Head Thickness
Same as XT except head thickness tolerance is held to ± 0.01 .

XH Reduced Head Diameter
Minimum head diameter equals:
 $D + 0.00, - 0.03$.

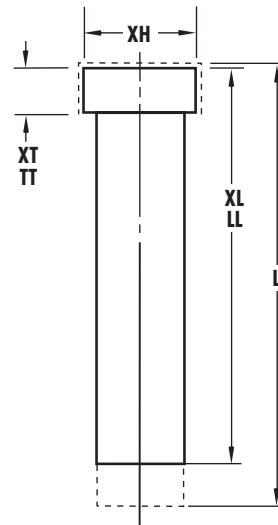

XN DayTride® a unique wear resistant surface treatment for M2 only.

XNT DAYTiN® Titanium Nitride coating for extra wear. For M2 only.

XNM An exclusive PVD solidlubricant coating. It provides a combination of lubricity and wear resistance not available from other PVD or CVD techniques. Produces a coefficient of friction lower than other coatings. Available on M2.

XCN TiCN® PVD coating ultra hardness (harder than carbide) and superior abrasive wear resistance. For M2 only.

How to Order:

Specify: Quantity
Type
Shank Code
Steel
Length Code
Standard Alterations

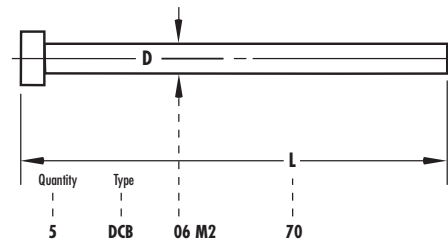

CLOSE SPACE PUNCHES TYPE DVB

Material	HRC
M2 (HSS)	60-63
Head	40-55

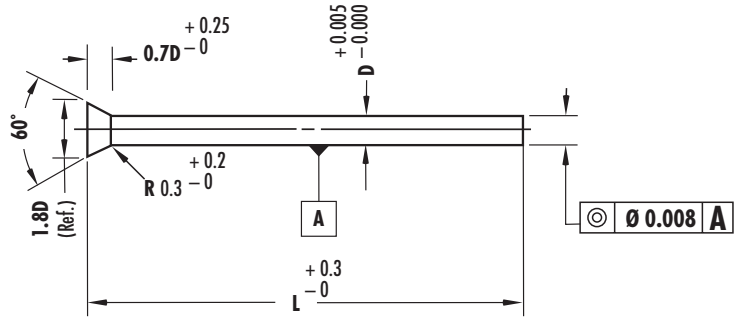
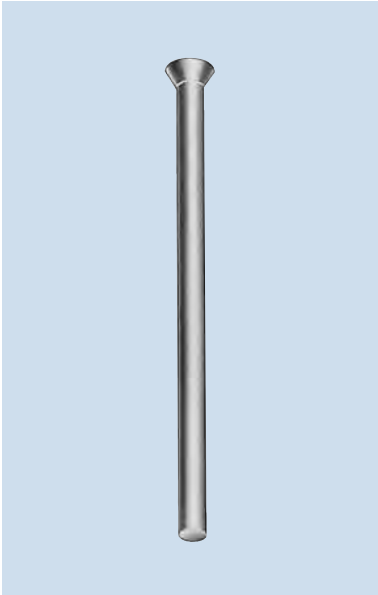

For Precision Close Space Holes

Steel: M2 – please specify when ordering

Body D	Head Dia. H	L								
		40.0	45.0	50.0	56.0	60.0	63.0	70.0	71.0	80.0
2.0	4.0									
3.0	5.0									
4.0	6.0									
5.0	7.0	40	45	50	56	60	63	70	71	80
6.0	8.0									
7.0	9.0									

Standard Alterations for DVB CloSPACE Punches

Standard alterations are the ranges beyond those sizes listed in the catalogue which can be manufactured for a slight additional charge.

XL Overall Length shortened
Stock removal from point end.

LL Precision Overall Length
Same as XL except overall length is held to ± 0.02 .

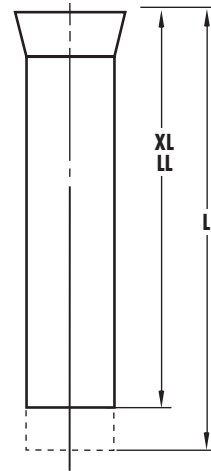

XN DayTride® a unique wear resistant surface treatment for M2 only.

XNT DAYTiN® Titanium Nitride coating for extra wear. For M2 only.

XNM An exclusive PVD solidlubricant coating. It provides a combination of lubricity and wear resistance not available from other PVD or CVD techniques. Produces a coefficient of friction lower than other coatings. Available on M2.

XCN TiCN® PVD coating ultra hardness (harder than carbide) and superior abrasive wear resistance. For M2 only.

How to Order:

Specify: Quantity
Type
Shank Code
Steel
Length Code
Standard Alterations

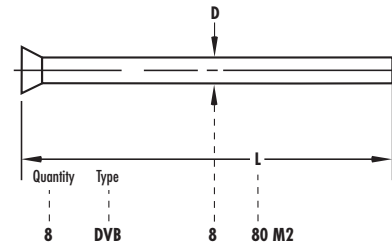

HEADED GUIDE BUSHINGS TYPE DE_

Material	HRC
A2 (HWS)	60-63
Head	40-55

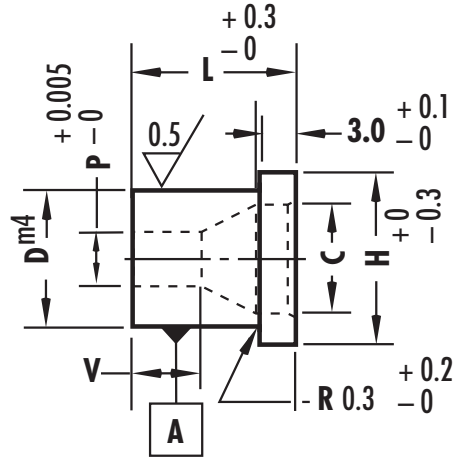

P	V
0.800-1.700	2P
1.701-2.400	P + 1.7
2.401-3.200	0.82P + 2.1

Head up

Steel: A2 – please specify when ordering

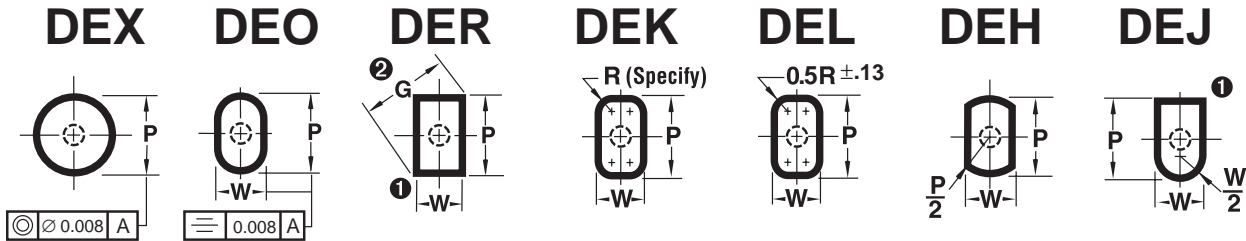

1 Sharp corners are typical. To assure proper clearance, Dayton will provide standard broken corners if matrix is ordered with punch to eliminate interference with matrix fillet when total clearance is 0.08 or less.

2 Check your P&W dimensions to be sure the diagonal G does not exceed the max. shown.

$$G = \sqrt{P^2 + W^2}$$

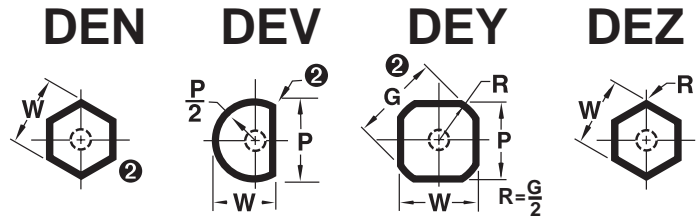

Type	Body		Round Range P	Shape		C' Bore Dia. C	L			
	D	H		Min. W	Max. P/G		8.0	10.0	13.0	16.0
DE_	5.0	8.0	1.60-3.20	1.30-3.20	3.6	•	•	•	•	
DE_	6.0	9.0	1.60-3.90	1.30-3.90	4.6		•	•	•	
DE_	8.0	11.0	2.40-5.40	1.30-5.40	6.6		•	•	•	
DE_	10.0	13.0	3.20-6.80	1.30-6.80	8.2		•	•	•	
DE_	13.0	16.0	5.40-8.80	1.90-8.80	11.4			•	•	
DE_	16.0	19.0	7.40-10.80	1.90-10.80	Full Taper				•	

Standard Alteration for DE_ Guide Bushings

XH

Reduced Head Diameter Minimum head diameter equals $D + 0.00, - 0.03$.

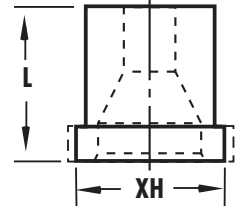

XT,

Thinner Head than standard Stock removal from head end which shortens overall length.

TT

Precision Head Thickness Same as XT except head thickness tolerance is held to ± 0.01 .

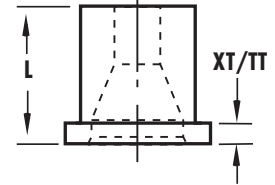

KEY FLATS

The standard location for a key flat is Parallel to the P dimensions.
For additional information see page 2.1.2 in the Die Buttons catalogue.

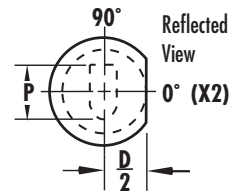

How to Order:

Specify: Quantity	4
Type	DEX
Shank & Length Codes	06 13
P or P&W Dimensions	P2.0
Standard Alterations	XH 7.0

HEADED GUIDE BUSHINGS TYPE DF_

Material	HRC
A2 (HWS)	60-63
Head	40-55

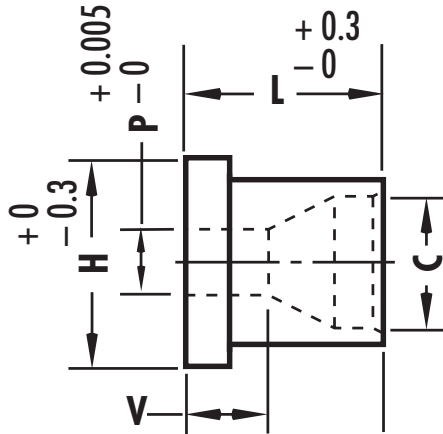

P	V
0.800-1.700	2P
1.701-2.400	P + 1.7
2.401-3.200	0.82P + 2.1

Head down

Steel: A2 – please specify when ordering

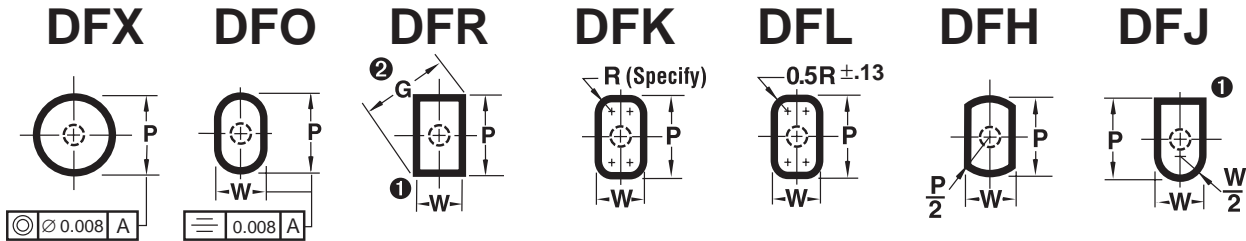

1 Sharp corners are typical. To assure proper clearance, Dayton will provide standard broken corners if matrix is ordered with punch to eliminate interference with matrix fillet when total clearance is 0.08 or less.

2 Check your P&W dimensions to be sure the diagonal G does not exceed the max. shown.

$$G = \sqrt{P^2 + W^2}$$

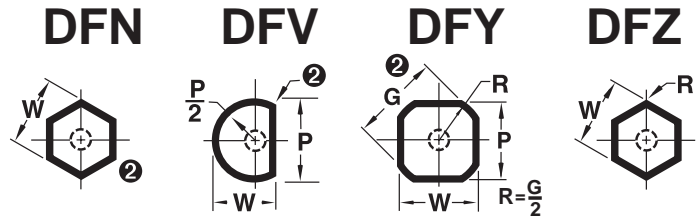

Type	Body		Round Range P	Shape		C' Bore Dia C	L			
	D	H		Min. W	Max. P/G		8.0	10.0	13.0	16.0
DF_	5.0	8.0	1.60-3.20	1.30-3.20	3.6	•	•	•		
DF_	6.0	9.0	1.60-3.90	1.30-3.90	4.6		•	•	•	
DF_	8.0	11.0	2.40-5.40	1.30-5.40	6.6		•	•	•	
DF_	10.0	13.0	3.20-6.80	1.30-6.80	8.2		•	•	•	
DF_	13.0	16.0	5.40-8.80	1.90-8.80	11.4			•	•	
DF_	16.0	19.0	7.40-10.80	1.90-10.80	Full Taper				•	

Standard Alteration for DF_ Guide Bushings

XH

Reduced Head Diameter Minimum head diameter equals $D + 0.00, - 0.03$.

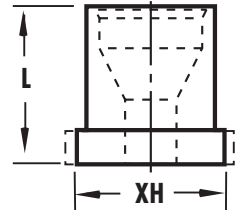

XT,

Thinner Head than standard Stock removal from head end which shortens overall length.

TT

Precision Head Thickness Same as XT except head thickness tolerance is held to ± 0.01 .

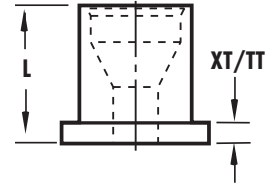

KEY FLATS

The standard location for a key flat is Parallel to the P dimensions.
For additional information see page 2.1.2 in the Die Buttons catalogue.

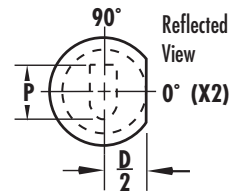

How to Order:

Specify:	Quantity	2
	Type	DFO
	Shank & Length Codes	10 10
	P or P&W Dimensions	P 3.5 W 2.9
	Standard Alterations	XP 7.0

HEADLESS GUIDE BUSHINGS TYPE DG_

Material	HRC
A2 (HWS)	60-63
Head	40-55

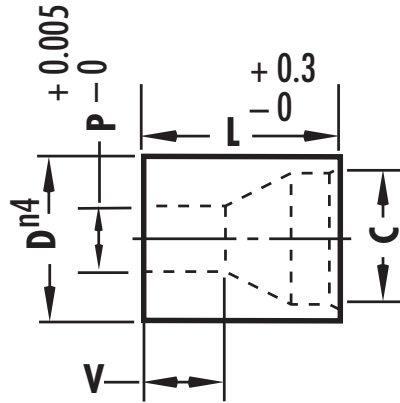

P	V
0.800-1.700	2P
1.701-2.400	P + 1.7
2.401-3.200	0.82P + 2.1

Headless

Steel: A2 – please specify when ordering

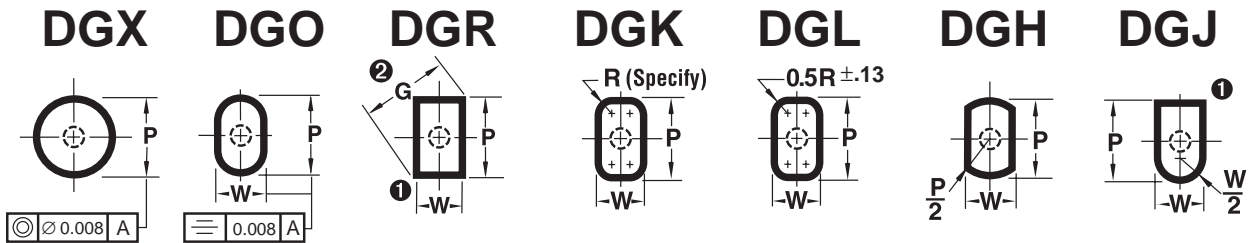

1 Sharp corners are typical. To assure proper clearance, Dayton will provide standard broken corners if matrix is ordered with punch to eliminate interference with matrix fillet when total clearance is 0.08 or less.

2 Check your P&W dimensions to be sure the diagonal G does not exceed the max. shown.

$$G = \sqrt{P^2 + W^2}$$

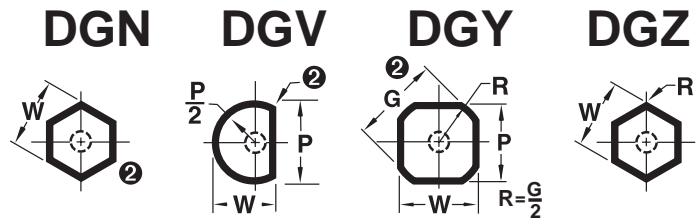

Type	Body D	Round Range P	Shape		C' Bore Dia. C	L			
			Min. W	Max. P/G		8.0	10.0	13.0	16.0
DG_	5.0	1.60-3.20	1.30	3.20	3.6	•	•	•	•
DG_	6.0	1.60-3.90	1.30	3.90	4.6	•	•	•	•
DG_	8.0	2.40-5.40	1.30	5.40	6.6	•	•	•	•
DG_	10.0	3.20-6.80	1.30	6.80	8.2	•	•	•	•
DG_	13.0	5.40-8.80	1.90	8.80	11.4	•	•	•	•
DG_	16.0	7.40-10.80	1.90	10.80	Full Taper	•	•	•	•

Standard Alteration for **DG**_ Guide Bushings

XP

P & W Dimensions Smaller than standard

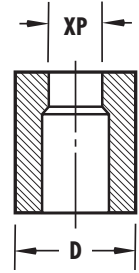

KEY FLATS

The standard location for a key flat is Parallel to the P dimensions.
For additional information see page 2.1.2 in the Die Buttons catalogue.

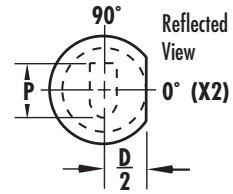

How to Order:

Specify: Quantity	4
Type	DGK
Shank & Length Codes	16 16
P or P&W Dimensions	P6.6 W6.1
Standard Alterations	R1.0

HEADED QUILL BUSHINGS TYPE DQX

Material	HRC
A2 (HWS)	60-63
Head	40-55

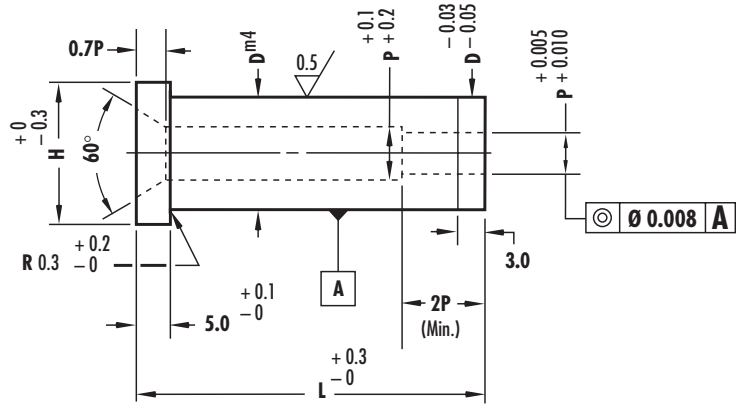

Steel: A2 – please specify when ordering

Body D	H	Punch Hole P	L		
			20.0	25.0	32.0
5.0	8.0	2.000			
6.0	9.0	3.000			
8.0	11.0	4.000	20	25	32
10.0	13.0	5.000			
13.0	16.0	6.000			

Standard Alterations for DQX Quill Bushings

Standard alterations are the ranges beyond those sizes listed in the catalogue which can be manufactured for a slight additional charge.

XD Reduced Shank Diameter

LIMITATIONS

Body Code XD	5.0	6.0	8.0	10.0	13.0
Min. XD	3.500	5.000	6.500	8.500	11.500
Max. D	1.700	2.500	3.200	4.000	6.000

XH Reduced Head Diameter

XL Overall Length shortened

XP P Dimensions Larger than standard

LIMITATIONS

Body Code XP	5.0	6.0	8.0	10.0	13.0
Min. P	1.70	1.70	1.70	1.70	1.70
Max. P	2.50	3.00	4.00	5.00	6.50

How to Order:

Specify: Quantity	3
Type	DQX
Shank & Length Codes	10 32
Steel	A2

CLASSIFIED SHAPES

Views

Views are Reflected View of Punch and Guide, Plan View of Matrix see opposite column.

Orientation and Locking

The Locking Device orientation is standard at 0°.

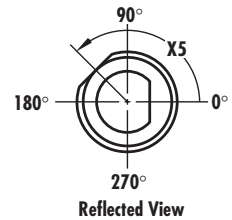

Clearance

Fillets matched with sharp corners reduces the clearance per side Δ . If the clearance is 0.04 Δ or less, Dayton will break sharp corners when the punches and/or guides and matrixes are ordered together. This reduces assembly time and the risk of edge breaking during operation.

Notes ① and ② – Fillets and Sharp Corners

Normal grinding methods produce:

- ① 0.2 max fillet on the punch matching corner sharp on the matrix.
- ② 0.2 max fillet on the matrix matching corner sharp on the punch.

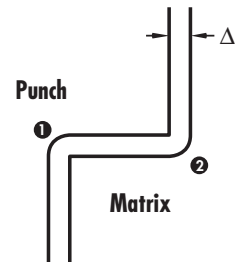

Shape Center

Shapes are centered on punch shanks as shown.

Shapes in guide bushings and matrixes are also centered as shown with the exception of shapes C22 and C34. Due to clearance, the P dimension on these shapes will not be centered.

Corner Dimensions

Dimensions should be to the theoretical sharp corners for shapes C22, C24, C25, C34, C61 and C88. Some reduction of these dimensions will result from fitting the punch and matrix under conditions where clearance is 0.04 or less per side.

Reflected View – Punches and Guides

The Reflected View is used for Punches and Guides. It is the view as seen in a mirror held below a punch or guide in its operating position. It is the same as a Plan View from the head end, in which the point shape is shown dotted except a Reflected View is shown with solid lines. The Reflected View simplifies design and eliminates confusion. Shapes on the part print, strip layout, punch, matrix and guide are the same basic view. Orientation for locking devices is the same position on all components.

Note: Must identify as REFLECTED VIEW on punch drawing.

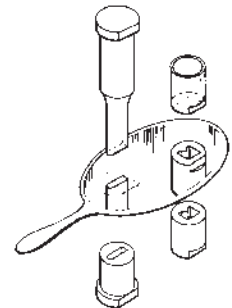

CLASSIFIED SHAPES

Orientation & Locking

X2 Standard Locations

The standard location of key flats is at 0°. Alternate locations of 90°, 180° or 270° can be specified at no extra cost (counter-clockwise from 0°). Additional information on page 4.2.1.

X5 Alternate Locations

Custom location of key flats is any angle other than 0°, 90°, 180° or 270° and is specified counter-clockwise from 0°. See page 4.2.1 for additional information.

Simplified Specifications

83 Common Shapes – No Detailing Required

90°

Flatted Rounds

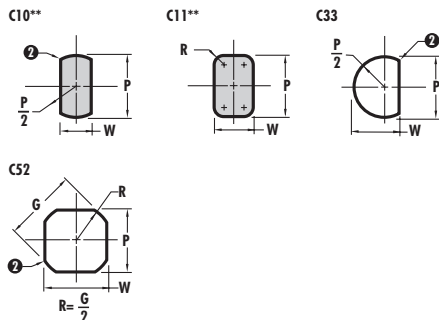

Mono Lobes

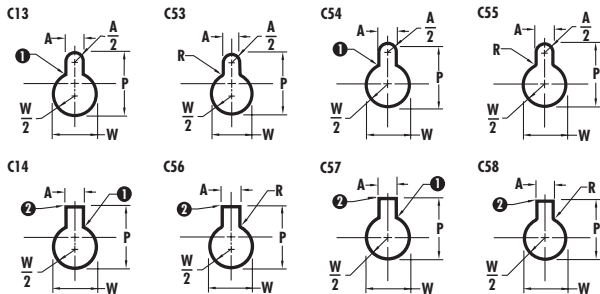

Miscellaneous

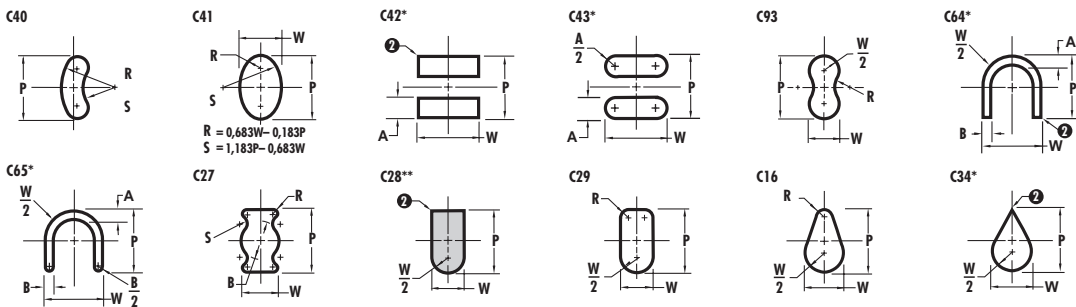

180°

0°

Triangles/Trapezoids

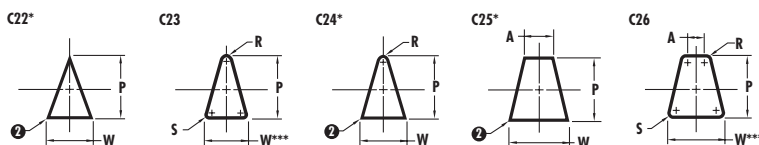

** Now a standard shape.

*** Tangential

Polygons

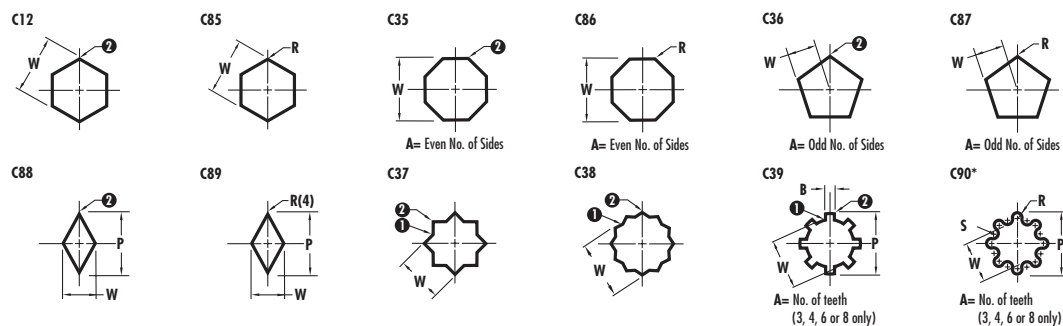

270°

90°

Keys

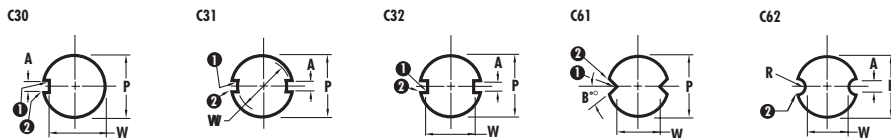

Multi Lobes

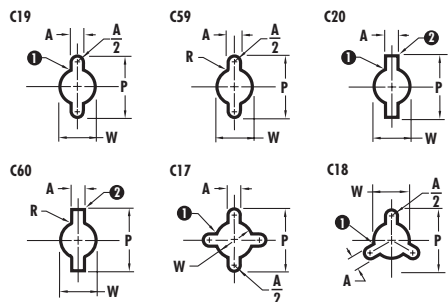

Duo Tees

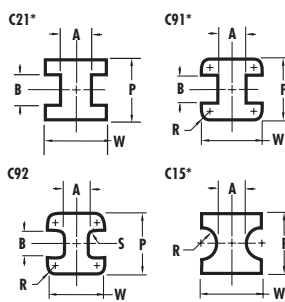

T's

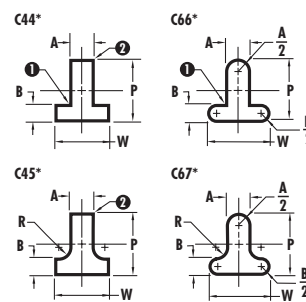

L's

180°

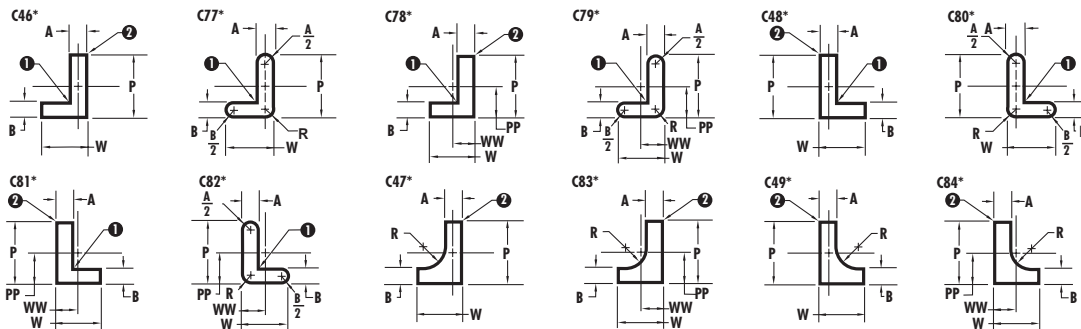

0°

U's

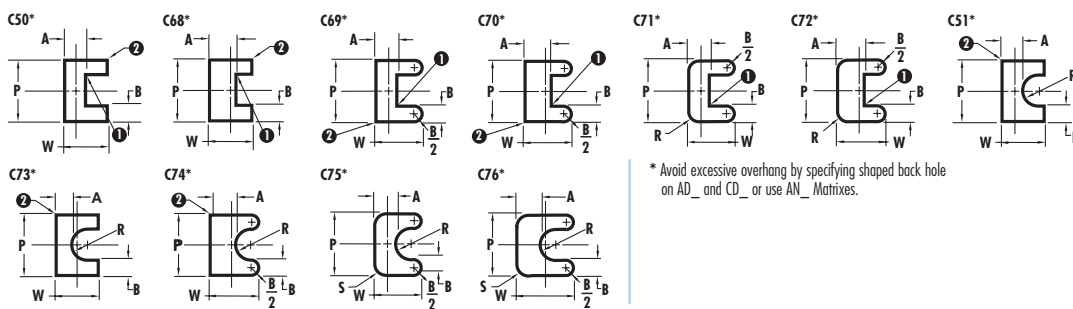

* Avoid excessive overhang by specifying shaped back hole on AD_ and CD_ or use AN_ Matrices.

270°

1 Sharp corners are typical. To assure proper clearance, Dayton will provide standard broken corners if matrix is ordered with punch to eliminate interference with matrix fillet when total clearance is 0.08 or less.

2 Check your P&W dimensions to be sure the diagonal G does not exceed the max. shown. If G exceeds the max.

$$G = \sqrt{P^2 + W^2}$$

How to order:

- Specify: Quantity
Type
Shank Diameter
Point & Overall Length
Steel
Standard Alterations
P or P&W Dimensions

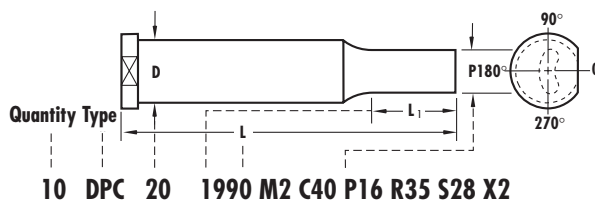

LOCKING DEVICES

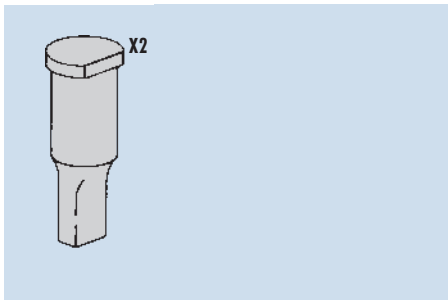

Definitions:

Standard Location is at 0°.

Alternate Location is 90°, 180° or 270°.

Alternate Locations are available at no additional charge.

Custom Location

is any angle other than: 0°, 90°, 180° or 270°.

Flats

	Single Flats X2	Single Flats X5
Locking Devices:	X2	X5
Punch	Top	Top

How to Order:

X2 – 90°

X5 – 135°

	Double Flats X3	Double Flats X6
Locking Devices:	X3	X6
Punch	Top	Top

How to Order:

X3 – 90°

X6 – 135°

Second flat is always parallel to the first flat.

F Dimension F (0.5 D on Headed Products) Headless Matrixes and Guides

Shank Dia.	05	06	08	10	13	16	20	22	25	32	38	40	45	50	56	63	71
F	2.2	2.6	3.5	4.3	5.6	6.9	8.7	9.5	10.8	13.8	16.5	17.4	19.5	21.7	24.2	27.3	30.7

Additional Flats

Code	Depth	Length	Code	Depth	Length
X81	1.5	13	X91	1.5	13
X82	1.5	16	X92	1.5	16
X83	1.5	20	X93	1.5	20
X84	1.5	Full Length	X94	1.5	Full Length
X85	2.5	13	X95	2.5	13
X86	2.5	16	X96	2.5	16
X87	2.5	20	X97	2.5	20
X88	2.5	Full Length	X98	2.5	Full Length
X89		Specify Dimensions	X99		Specify Dimensions

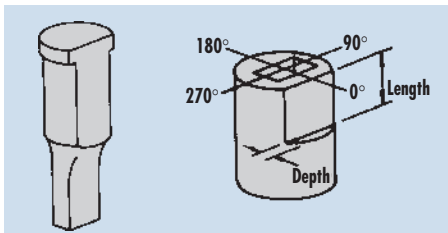

Note: Depth of flat is taken from shank, not the head on punches.

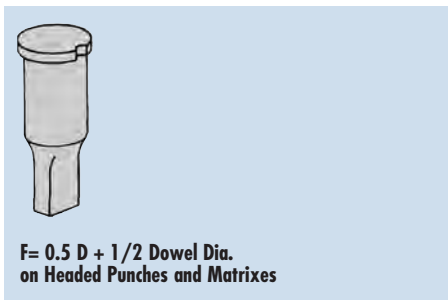

F = 0.5 D + 1/2 Dowel Dia.
on Headed Punches and Matrixes

Dowel Slots

	X0, X4, X41, X43	X1, X7, X71, X73
Locking Devices:	X0 X4 X41 X43	X0 X4 X41 X43
Dowel Dia.	3.0 3.0 4.0 6.0	3.0 3.0 4.0 6.0

How to Order:

X0 – 180°

X71 – 135°

F Dimensions for Headless Matrixes Only

Body Ø		05	06	08	10	13	16-25	32-71
X0/X1	F	0.5D	0.5D	0.5D	0.5D	0.5D	0.5D	0.5D
X4/X7	F	3.5	3.9	4.7	5.5	6.7	0.5D	0.5D
X41/X71	F	4.0	4.4	5.2	6.0	7.2	0.5D	0.5D
X43/X73	F	5.0	5.4	6.2	7.0	8.2	0.5D+1.0	0.5D

How to Order:

5 DJR 20 1350 M2 P16.40 W10.20 X2-90°

Key Flats vs. Dowel Slots

maximum hole dimensions in matrixes were designed with key flats in mind. There are instances where, if using a dowel slot, the dowel hole could break into the relief. For this reason there are two ways to specify the location of the dowel. **X0** (standard/alternate location) and **X1** (custom location) are located .5D from centerline. However, when hole dimensions are approaching the high limit of "P" **X4** (standard/alternate location) or **X7** (custom location) may be specified. This relocates the dowel outward to assure no interference between the dowel and relief. Note, when the matrix diameter is 16-71 the centerline dimension is 0.5D on all dowels.

Orientation

The Standard location for all locking devices is 0° and is always on the long side (P) of the shape. Custom locations are measured counterclockwise from 0°.

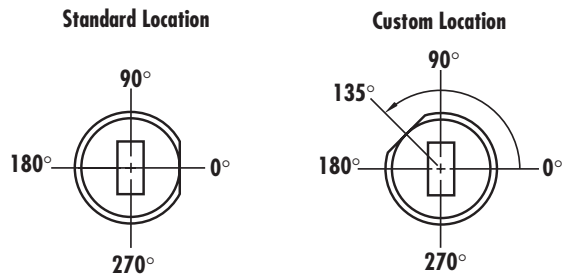

Views

A Plan View is used for the matrix and a Reflected View is used for the punch or guide. The Reflected View a mirror image simplifies orientation all locking devices are in the same position.

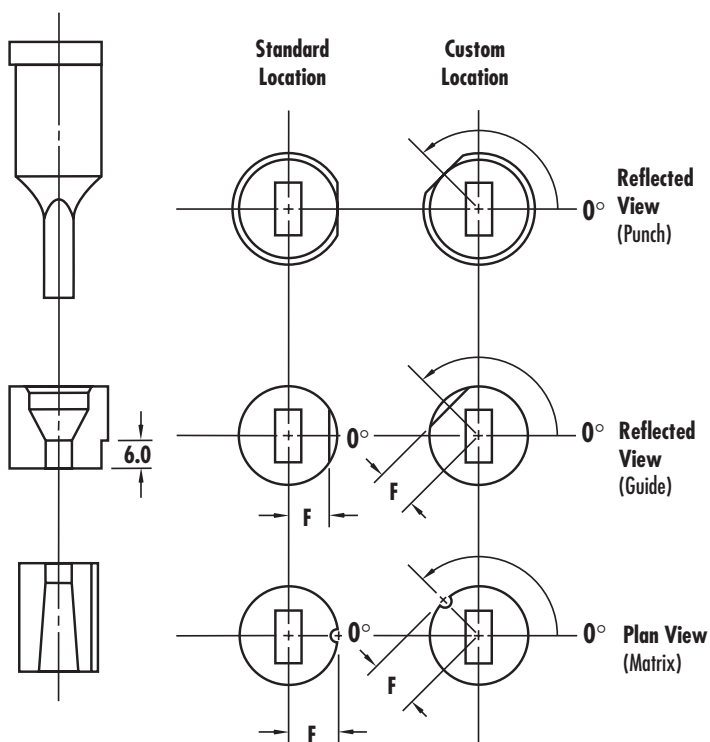
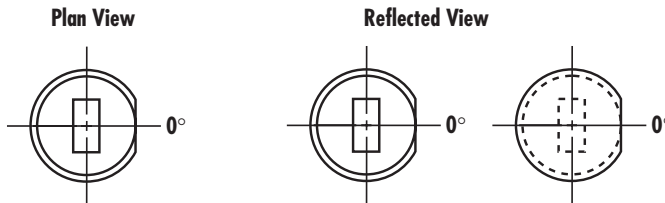

How to Specify

The most common locking devices, flat, double flat and dowel are available. Select the type then add the code to the component descriptions shown to the right.

How to Order:

1 DJJ 13-2563 P 8.0 W 6.5 M2 X2

Location Tolerance

Flat	F	Radial	Dowel	F	Radial
	+ 0.005	0.01/20		+ 0.005	0° 2'
	- 0.000			- 0.000	



JEKTOLE® COMPONENTS



Jektrole® in Production

- Requires less press tonnage
- Reduces pressure required to strip the punch... which in turn reduces punch wear
- Produces minimal burr
- Doubles (and often triples) piece output per grind
- Reduces total punch costs

Jektrole® in Maintenance

- Keeper Key – holds pin in retracted position
- Eliminates the need for disassembly before grinding
- Maintains proper pin extension
- Reduces downtime for re-grinding

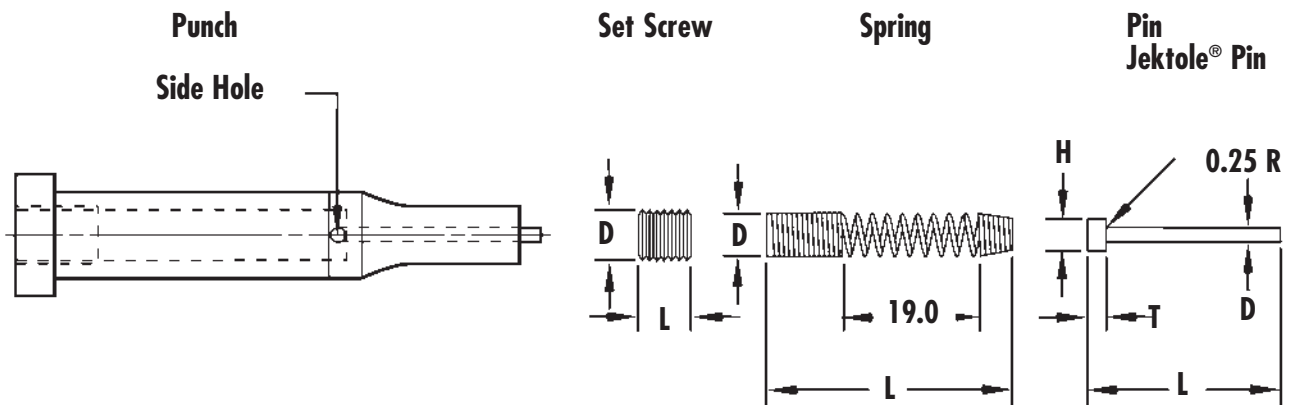

Universal Jektrole® Components

Ejector Pins		J2M	J3M	J4M	J6M	J9M	J12M
Overall Length	L	28.0	35.0	49.4	49.4	56.5	56.5
Pin Diameter	D	0.43	0.68	1.04	1.47	2.26	3.05
Head Diameter	H	1.2	1.8	2.4	3.0	4.0	4.8
Head Thickness	T	0.8	1.2	1.6	1.6	2.4	2.4

Springs		J2M	J3M	J4M	J6M	J9M	J12M
Outside Diameter	D	2.1	2.4	3.3	4.3	5.0	7.0
Free Length	L	60.3	60.3	81.0	76.2	68.9	65.1

Screws		J2M	J3M	J4M	J6M	J9M	J12M
Screw Size	D	M2.6	M3	M4	M5	M6	M8
Screw	L	5.0	5.0	5.0	5.0	6.0	6.0

Jektrole® Design Limits

Dimensions		J2M	J3M	J4M	J6M	J9M	J12M
Min. Shank Dia.	D	4.4	5.0	6.8	8.8	10.4	14.0
Min. Point Dia.	P	1.3	2.0	3.0	4.0	6.0	7.2
Max. Point Length		32	38	41	41	41	41
Max. Shank Length	S	87	87	84	84	84	70